



## Teaching Guide

NEW





# COUNTDOWN

Second Edition

OXFORD  
UNIVERSITY PRESS



# Contents

 <b>Introduction</b>	<b>iv</b>
 <b>Curriculum</b>	<b>1</b>
<ul style="list-style-type: none"><li>• Strands and Benchmarks</li><li>• Syllabus Matching Grid</li></ul>	
 <b>Teaching and Learning</b>	<b>12</b>
<ul style="list-style-type: none"><li>• Guiding Principles</li><li>• Mathematical Practices</li><li>• Lesson Planning</li><li>• Features of the Teaching Guide</li><li>• Sample Lesson Plans</li></ul>	
 <b>Assessment</b>	<b>74</b>
<ul style="list-style-type: none"><li>• Specimen Paper</li><li>• Marking Scheme</li></ul>	

# Introduction

Welcome, users of the Countdown series. Countdown has been the choice of Mathematics teachers for many years. This Teaching Guide has been specially designed to help them teach mathematics in the best possible manner. It will serve as a reference book to streamline the teaching and learning experience in the classroom.

Teachers are entrusted with the task of providing support and motivation to their students, especially those who are at the lower end of the spectrum of abilities. In fact, their success is determined by the level of understanding demonstrated by the least able students.

Teachers regulate their efforts and develop a teaching plan that corresponds to the previous knowledge of the students and difficulty of the subject matter. The more well-thought out and comprehensive a teaching plan is, the more effective it is. This teaching guide will help teachers streamline the development of a lesson plan for each topic and guide the teacher on the level of complexity and amount of practice required for each topic. It also helps the teacher introduce effective learning tools to the students to complete their learning process.

Shazia Asad



# Curriculum

## ► Strands and Benchmarks

(National Curriculum for Mathematics 2006)

The National Curriculum for Mathematics 2006 is based on these five strands:

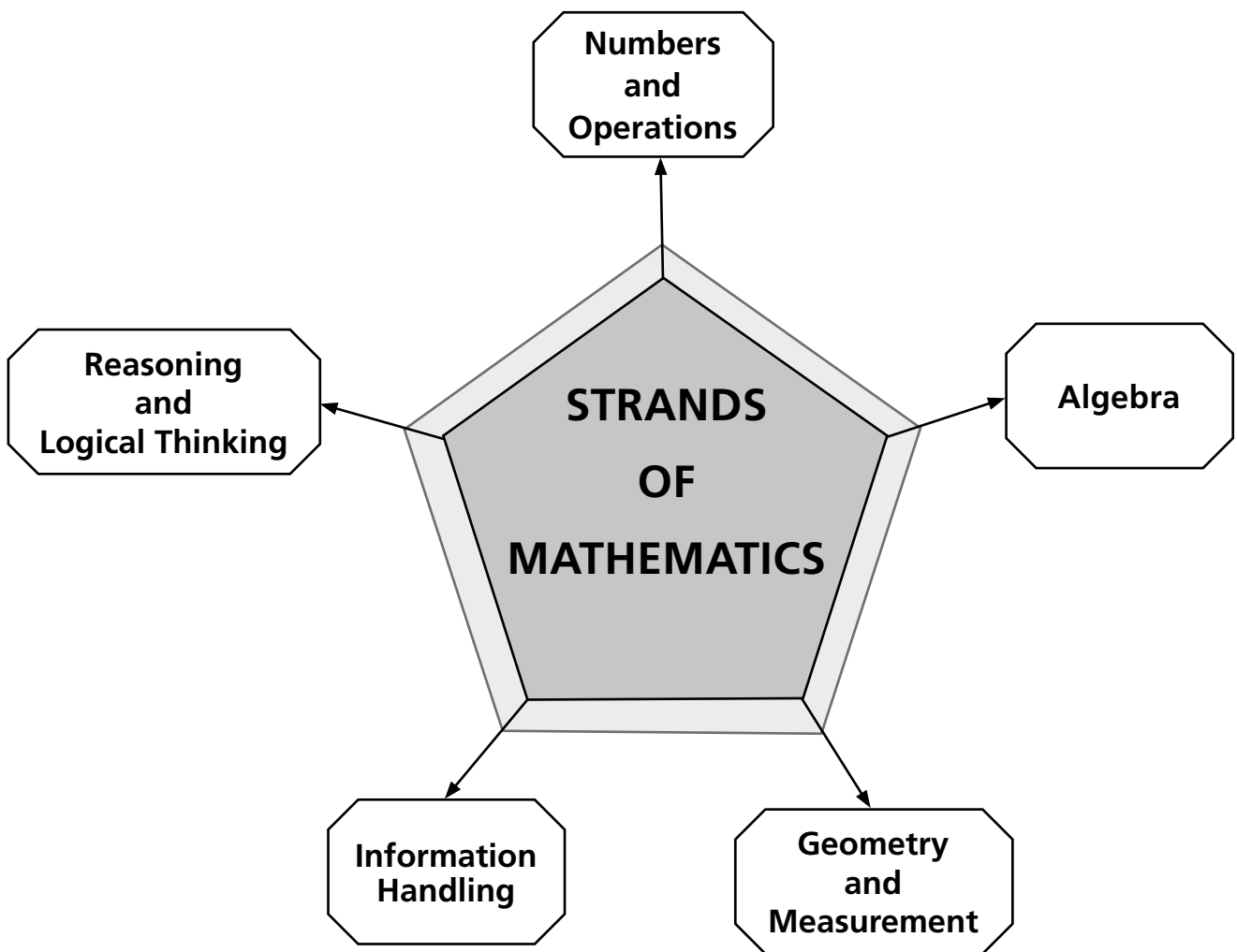

## **Towards greater focus and coherence of a mathematical programme**

A comprehensive and coherent mathematical programme needs to allocate proportional time to all strands. A composite strand covers number, measurement and geometry, algebra, and information handling.

Each strand requires a focussed approach to avoid the pitfall of a broad general approach. If, say, an algebraic strand is approached, coherence and intertwining of concepts within the strand at all grade levels is imperative. The aims and objectives of the grades below and above should be kept in mind.

“What and how students are taught should reflect not only the topics that fall within a certain academic discipline, but also the key ideas that determine how knowledge is organised and generated within that discipline.”

William Schmidt and Richard Houang (2002)

## **Strands and Benchmarks of the Pakistan National Curriculum (2006)**

### **Strand 1: Numbers and Operations**

The students will be able to:

- identify numbers, ways of representing numbers, and effects of operations in various situations;
- compute fluently with fractions, decimals, and percentages, and
- manipulate different types of sequences and apply operations on matrices.

### **Benchmarks**

#### **Grades VI, VII, VIII**

- Identify different types of sets with notations
- Verify commutative, associative, distributive, and De Morgan’s laws with respect to union and intersection of sets and illustrate them through Venn diagrams
- Identify and compare integers, rational, and irrational numbers
- Apply basic operations on integers and rational numbers and verify commutative, associative, and distributive properties
- Arrange absolute values of integers in ascending and descending order
- Find HCF and LCM of two or more numbers using division and prime factorization
- Convert numbers from decimal system to numbers with bases 2, 5, and 8, and vice versa
- Add, subtract, and multiply numbers with bases 2, 5, and 8
- Apply the laws of exponents to evaluate expressions
- Find square and square root, cube, and cube root of a real number
- Solve problems on ratio, proportion, profit, loss, mark-up, leasing, *zakat*, *ushr*, taxes, insurance, and money exchange

## Strand 2: Algebra

The students will be able to:

- analyse number patterns and interpret mathematical situations by manipulating algebraic expressions and relations;
- model and solve contextualised problems; and
- interpret functions, calculate rate of change of functions, integrate analytically and numerically, determine orthogonal trajectories of a family of curves, and solve non-linear equations numerically.

### Benchmarks

#### Grades VI, VII, VIII

- Identify algebraic expressions and basic algebraic formulae
- Apply the four basic operations on polynomials
- Manipulate algebraic expressions using formulae
- Formulate linear equations in one and two variables
- Solve simultaneous linear equations using different techniques

## Strand 3: Measurement and Geometry

The students will be able to:

- identify measurable attributes of objects, and construct angles and two dimensional figures;
- analyse characteristics and properties and geometric shapes and develop arguments about their geometric relationships; and
- recognise trigonometric identities, analyse conic sections, draw and interpret graphs of functions.

### Benchmarks

#### Grades VI, VII, VIII

- Draw and subdivide a line segment and an angle
- Construct a triangle (given SSS, SAS, ASA, RHS), parallelogram, and segments of a circle
- Apply properties of lines, angles, and triangles to develop arguments about their geometric relationships
- Apply appropriate formulas to calculate perimeter and area of quadrilateral, triangular, and circular regions
- Determine surface area and volume of a cube, cuboid, sphere, cylinder, and cone
- Find trigonometric ratios of acute angles and use them to solve problems based on right-angled triangles

### **Strand 4: Handling Information**

The students will be able to collect, organise, analyse, display, and interpret data.

#### **Benchmarks**

##### **Grades VI, VII, VIII**

- Read, display, and interpret bar and pie graphs
- Collect and organise data, construct frequency tables and histograms to display data
- Find measures of central tendency (mean, median and mode)

### **Strand 5: Reasoning and Logical Thinking**

The students will be able to:

- use patterns, known facts, properties, and relationships to analyse mathematical situations;
- examine real-life situations by identifying mathematically valid arguments and drawing conclusions to enhance their mathematical thinking.

#### **Benchmarks**

##### **Grades VI, VII, VIII**

- Find different ways of approaching a problem to develop logical thinking and explain their reasoning
- Solve problems using mathematical relationships and present results in an organised way
- Construct and communicate convincing arguments for geometric situations



## ► Syllabus Matching Grid

Unit 1: Sets	
<p><b>1.1 Set</b></p> <p>i) Define set. Recognise notation of a set and its objects/elements. ii) Describe tabular form of a set and demonstrate through examples.</p>	Chapter 1
<p><b>1.2 Types of Set</b></p> <p>Define</p> <ul style="list-style-type: none"> <li>• finite and infinite sets,</li> <li>• empty/void/null set,</li> <li>• singleton,</li> <li>• equal and equivalent sets,</li> <li>• subset and superset of a set,</li> <li>• proper and improper subsets of a set, and demonstrate through examples.</li> </ul>	
Unit 2: Whole Numbers	
<p><b>2.1 Natural and Whole Numbers</b></p> <p>i) Differentiate between natural and whole numbers. ii) Identify natural and whole numbers and their notations. iii) Represent</p> <ul style="list-style-type: none"> <li>• a given list of whole numbers,</li> <li>• whole numbers <math>&lt;</math> (or <math>&gt;</math>) a given whole number,</li> <li>• whole numbers <math>\geq</math> (or <math>\leq</math>) a given whole number,</li> <li>• whole numbers <math>&gt;</math> but <math>&lt;</math> a given whole number,</li> <li>• whole numbers <math>\geq</math> but <math>\leq</math> a given whole number,</li> <li>• sum of two or more given whole numbers on the number line.</li> </ul>	Chapter 2
<p><b>2.2 Addition and Subtraction of Whole Numbers</b></p> <p>i) Add and subtract two given whole numbers. ii) Verify commutative and associative laws (under addition) of whole numbers. iii) Recognise '0' as additive identity.</p>	Chapter 2
<p><b>2.3 Multiplication and Division of Whole Numbers</b></p> <p>i) Multiply and divide two given whole numbers. ii) Verify commutative and associative laws (under multiplication) of whole numbers. iii) Recognise '1' as multiplicative identity.</p>	
<p><b>2.4 Multiplication and Addition/Subtraction of Whole Numbers</b></p> <p>i) Verify distributive law of multiplication over addition. ii) Verify distributive law of multiplication over subtraction (with positive difference).</p>	

<b>Unit 3: Factors and Multiples</b>	
<p><b>3.1 Factors and Multiples</b></p> <p>i) Define a factor as a number which divides the dividend completely, leaving no remainder.</p> <p>ii) Define a multiple as a dividend into which a factor can divide.</p> <p>iii) Define even numbers as numbers which are multiples of 2.</p> <p>iv) Define odd numbers as numbers which are not multiples of 2.</p> <p>v) Define prime numbers as numbers which have only two factors (i.e., 1 and itself).</p> <p>vi) Define composite numbers as numbers which have more than two factors.</p> <p>vii) Know that 1 is neither prime nor composite as it has only one factor which is 1 itself.</p> <p>viii) Know that 1 is a factor of every number.</p> <p>ix) Know that 2 is the only even prime number whereas all other prime numbers are odd.</p>	Chapter 3
<p><b>3.2 Tests for Divisibility</b></p> <p>Test by inspection whether the numbers 2, 3, 4, 5, 6, 8, 9, 10, 11, 12, 15 and 25 can divide a given number.</p>	
<p><b>3.3 Factorization</b></p> <p>i) Define prime factorization as the process of factorising a number into its prime factors.</p> <p>ii) Recognise index notation.</p> <p>iii) Factorise a given number and express its factors in index notation.</p>	Chapter 4
<p><b>3.4 HCF</b></p> <p>i) Define HCF as the greatest number which is a common factor of two or more numbers.</p> <p>ii) Find the HCF of two or more than two numbers by</p> <ul style="list-style-type: none"> <li>• prime factorization,</li> <li>• long division method.</li> </ul>	
<p><b>3.5 LCM</b></p> <p>i) Define LCM as the smallest number which is a common multiple of two or more numbers.</p> <p>ii) Find the LCM of two or more numbers by</p> <ul style="list-style-type: none"> <li>• prime factorization,</li> <li>• division method.</li> </ul>	Chapter 4
<p><b>3.6 Applications of HCF and LCM</b></p> <p>Solve real-life problems related to HCF and LCM.</p>	

## Unit 4: Integers

### 4.1 Integers

- i) Know that
- the natural numbers 1, 2, 3, ... are also called positive integers and the corresponding negative numbers  $-1, -2, -3 \dots$ , are called negative integers,
  - '0' is an integer which is neither positive nor negative.
- ii) Recognise integers.

### 4.2 Ordering of Integers

- i) Represent integers on a number line.
- ii) Know that on a number line any number lying
- to the right of zero is positive,
  - to the left of zero is negative,
  - to the right of another number is greater,
  - to the left of another number is smaller.
- iii) Know that every positive integer is greater than a negative integer.
- iv) Know that every negative integer is less than a positive integer.
- v) Arrange a given list of integers in ascending and descending order.

### 4.3 Absolute or Numerical Value of an Integer

- i) Define the absolute or numerical value of a number as its distance from zero on a number line and this is always positive.
- ii) Arrange the absolute or numerical values of given integers in ascending and descending order.

### 4.4 Addition of Integers

- i) Use a number line to display the:
- sum of two or more given negative integers,
  - difference of two given positive integers,
  - sum of two given integers.
- ii) Add two integers (with like signs) in the following three steps:
- a) Take the absolute values of the given integers.
  - b) Add the absolute values.
  - c) Give the result the common sign.
- iii) Add two integers (with unlike signs) in the following three steps:
- a) Take the absolute values of the given integers.
  - b) Subtract the smaller absolute value from the larger.
  - c) Give the result the sign of the integer with the larger absolute value.

Chapter 5

Chapter 5

<p><b>4.5 Subtraction of Integers</b></p> <p>i) Recognise subtraction as the inverse process of addition.</p> <p>ii) Subtract one integer from another by changing the sign of the integer being subtracted and adding according to the rules for addition of integers.</p>	<p>Chapter 5</p>
<p><b>4.6 Multiplication of Integers</b></p> <p>Recognise that</p> <ul style="list-style-type: none"> <li>• the product of two integers of like signs is a positive integer.</li> <li>• the product of two integers of unlike signs is a negative integer.</li> </ul>	
<p><b>4.7 Division of Integers</b></p> <p>i) Recognise that division is the inverse process of multiplication.</p> <p>ii) Recognise that on dividing one integer by another</p> <ul style="list-style-type: none"> <li>• if both the integers have like signs, the quotient is positive.</li> <li>• if both the integers have unlike signs, the quotient is negative.</li> </ul> <p>iii) Know that division of an integer by '0' is not possible.</p>	
<p><b>Unit 5: Simplifications</b></p>	
<p><b>5.1 BODMAS Rule</b></p> <p>i) Know that the following four kinds of brackets</p> <ul style="list-style-type: none"> <li>• <math>\overline{\quad}</math> vinculum,</li> <li>• ( ) parentheses or curved brackets or round brackets;</li> <li>• { } braces or curly brackets;</li> <li>• [ ] square brackets or box brackets</li> </ul> <p>are used to group two or more numbers together with operations.</p> <p>ii) Know the order of preference as, <math>\overline{\quad}</math>, ( ), { } and [ ], to remove (simplify) them from an expression.</p> <p>iii) Recognise the BODMAS rule to determine the order in which the operations to simplify mathematical expressions are performed.</p> <p>iv) Simplify mathematical expressions involving fractions and decimals grouped with brackets using the BODMAS rule.</p> <p>v) Solve real-life problems involving fractions and decimals.</p>	<p>Concept used in algebra Chapter 8</p>
<p><b>Unit 6: Ratio and Proportion</b></p>	
<p><b>6.1 Ratio</b></p> <p>i) Define ratio as a relationship which one quantity bears to another quantity of the same kind with regard to their magnitudes.</p> <p>ii) Know that of the two quantities forming a ratio, the first one is called the antecedent and the second one the consequent.</p> <p>iii) Know that a ratio has no units.</p> <p>iv) Calculate the ratio of two numbers.</p> <p>v) Reduce a given ratio to its lowest (equivalent) form.</p> <p>vi) Describe the relationship between a ratio and a fraction.</p>	<p>Chapter 6</p>

<p><b>6.2 Proportion</b></p> <p>i) Know that an equality of two ratios constitutes a proportion, e.g., <math>a:b :: c:d</math>, where <math>a, d</math> are known as extremes and <math>b, c</math> are called the means.</p> <p>ii) Find proportion (direct and inverse).</p> <p>iii) Solve real-life problems involving direct and inverse proportion.</p>	Chapter 6
<b>Unit 7 Financial Arithmetic</b>	
<p><b>7.1 Percentage</b></p> <p>i) Recognise percentage as a fraction with denominator of 100.</p> <p>ii) Convert a percentage to a fraction by expressing it as a fraction with denominator 100 and then simplify.</p> <p>iii) Convert a fraction to a percentage by multiplying it by 100%.</p> <p>iv) Convert a percentage to a decimal by expressing it as a fraction with denominator 100 and then as a decimal.</p> <p>v) Convert a decimal to a percentage by expressing it as a fraction with denominator 100 and then as a percentage.</p> <p>vi) Solve real-life problems involving percentages.</p>	Chapter 7
<p><b>7.2 Profit, Loss, and Discount</b></p> <p>i) Define</p> <ul style="list-style-type: none"> <li>• selling price and cost price;</li> <li>• profit, loss, and discount;</li> <li>• profit percentage and loss percentage.</li> </ul> <p>ii) Solve real-life problems involving profit, loss, and discount.</p>	Chapter 7
<b>Unit 8: Introduction to Algebra</b>	
<p><b>8.1 Algebra</b></p> <p>i) Explain the term algebra as an extension of arithmetic in which letters replace the numbers.</p> <p>ii) Know that</p> <ul style="list-style-type: none"> <li>• a sentence is a set of words making a complete grammatical structure and conveying full meaning;</li> <li>• sentences that are either true or false are known as statements;</li> <li>• a statement must be either true or false but not both;</li> <li>• a sentence that does not include enough information required to decide whether it is true or false is known as an open statement (e.g., <math>\Delta + 2 = 9</math>);</li> <li>• a number that makes an open statement true is said to satisfy the statement (e.g. <math>\Delta = 7</math> makes the statement <math>\Delta + 2 = 9</math> true);</li> <li>• use English letter <math>x</math> in the open statement <math>\Delta + 2 = 9</math> to modify it to <math>x + 2 = 9</math>.</li> </ul> <p>iii) Define variables as letters used to denote numbers in algebra.</p> <p>iv) Know that any numeral, variable, or combination of numerals and variables connected by one or more of the symbols '+' and '-' is know as an algebraic expression.</p>	Chapter 8

<p><b>8.2 Algebraic Expression</b></p> <p>i) Know that <math>x</math>, <math>2y</math>, and <math>5</math> are called the terms of the expression <math>x + 2y + 5</math>.</p> <p>ii) Know that the symbol or number appearing as a multiple of a variable used in an algebraic term is called its coefficient (e.g. in <math>2y</math>, <math>2</math> is the coefficient of <math>y</math>).</p> <p>iii) Know that the number appearing in an algebraic expression independent of a variable is called a constant term (e.g. in <math>x + 2y + 5</math>, number <math>5</math> is a constant).</p> <p>iv) Differentiate between like and unlike terms.</p> <p>v) Know that:</p> <ul style="list-style-type: none"> <li>• like terms can be combined to give a single term.</li> <li>• addition or subtraction cannot be performed with unlike terms.</li> </ul> <p>vi) Add and subtract given algebraic expressions.</p> <p>vii) Simplify algebraic expressions grouped with brackets.</p> <p>viii) Evaluate and simplify an algebraic expression when the values of the variables involved are given.</p>	Chapter 8
<b>Unit 9: Linear Equations</b>	
<p><b>9.1 Algebraic Equations</b></p> <p>i) Define an algebraic equation.</p> <p>ii) Differentiate between an equation and an expression.</p>	Chapter 9
<p><b>9.2 Linear Equations</b></p> <p>i) Define a linear equation in one variable.</p> <p>ii) Construct a linear expression and a linear equation in one variable.</p> <p>iii) * Solve simple linear equations involving fractional and decimal coefficients like <math>-\frac{1}{2}x + 5 = x - \frac{1}{3}</math>.</p> <p>iv) Solve real-life problems involving linear equations.</p>	Chapter 9 and *Book 7 Chapter 11
<b>Unit 10: Geometry</b>	
<p><b>10.1 Line Segments</b></p> <p>i) Add the lengths of two or more line segments.</p> <p>ii) Subtract the lengths of a line segment from a longer one.</p> <p>iii) Draw a right bisector of a given line segment using compasses.</p> <p>iv) Draw a perpendicular to a given line from a point on it using compasses.</p> <p>v) * Draw a perpendicular to a given line from a point outside the line, using compasses.</p>	Chapter 11 and *Book 7 Chapter 12
<p><b>10.2 Construction of Angles</b></p> <p>Use compasses to</p> <ul style="list-style-type: none"> <li>• construct an angle equal in size to a given angle;</li> <li>• construct an angle twice the size of a given angle;</li> <li>• * bisect a given angle;</li> <li>• divide a given angle into four equal angles;</li> <li>• construct the following angles: <math>60^\circ, 30^\circ, 15^\circ, 90^\circ, 45^\circ, (22\frac{1}{2}^\circ), 75^\circ, 120^\circ, 150^\circ, 165^\circ, 135^\circ, (67\frac{1}{2}^\circ), 105^\circ</math>.</li> </ul>	Chapter 12 and *Book 7 Chapter 13

<p><b>10.3 Construction of Triangles</b></p> <p>i) * Construct a triangle when three sides (SSS) are given.  <b>Caution:</b> Sum of two sides should be greater than the third side.</p> <p>ii) * Construct a triangle when two sides and their included angle (SAS) are given.</p> <p>iii) * Construct a triangle when two angles and the included side (ASA) are given.</p> <p>iv) * Construct a right-angled triangle when hypotenuse and one side (RHS) are given.</p>	<p>*Book 7 Chapter 13</p>
<p><b>Unit 11: Perimeter and Area</b></p>	
<p><b>11.1 Perimeter and Area</b></p> <p>i) Find the perimeter and area of a square and a rectangle.</p> <p>ii) Find the area of a path inside or outside of a rectangle or square.</p> <p>iii) Solve real-life problems related to perimeter and area of a square and rectangle.</p> <p>iv) * Recognise the altitude of a geometric figure as the measure of the shortest distance between the base and its top.</p> <p>v) * Find the area of a parallelogram when altitude and base are given.</p> <p>vi) * Define a trapezium and find its area when the altitude and lengths of the parallel sides are given.</p> <p>vii) * Find the area of a triangle when the lengths of the altitude and base are given.</p>	<p>Chapter 14</p> <p>*Book 7 Chapter 13</p>
<p><b>Unit 12 : Three Dimensional Solids</b></p>	
<p><b>12.1 Volume and Surface Area</b></p> <p>i) Identify 3D figures (cube, cuboid, sphere, cylinder, and cone) with respect to their faces, edges, and vertices.</p> <p>ii) Define and recognise units of surface area and volume.</p> <p>iii) Find the surface area and volume of a cube and cuboid.</p> <p>iv) Solve real-life problems involving volume and surface area.</p>	<p>Chapter 15</p>
<p><b>Unit 13: Information Handling</b></p>	
<p><b>13.1 Types of Data</b></p> <p>i) Define data and data collection.</p> <p>ii) Distinguish between grouped and ungrouped data.</p>	<p>Chapter 16</p>
<p><b>13.2 Bar Graph</b> Draw horizontal and vertical bar graphs.</p>	
<p><b>13.3 Pie Graph</b> Read a pie graph.</p>	<p>*Book 7 Chapter 19</p>



# Teaching and Learning

## ► Guiding Principles

1. Students explore mathematical ideas in ways that maintain their enjoyment of and curiosity about mathematics, help them develop depth of understanding, and reflect real-world applications.
2. All students have access to high quality mathematics programmes.
3. Mathematics learning is a lifelong process that begins and continues in the home and extends to school, community settings, and professional life.
4. Mathematics instruction both connects with other disciplines and moves toward integration of mathematical domains.
5. Working together in teams and groups enhances mathematical learning, helps students communicate effectively, and develops social and mathematical skills.
6. Mathematics assessment is a multifaceted tool that monitors student performance, improves instruction, enhances learning, and encourages student self-reflection.

## Principle 1

Students explore mathematical ideas in ways that maintain their enjoyment of and curiosity about mathematics, help them develop depth of understanding, and reflect real-world applications.

- The understanding of mathematical concepts depends not only on what is taught, but also hinges on the way the topic is taught.
- In order to plan developmentally appropriate work, it is essential for teachers to familiarise themselves with each individual student's mathematical capacity.
- Students can be encouraged to muse over their learning and express their reasoning through questions such as;
  - *How did you work through this problem?*
  - *Why did you choose this particular strategy to solve the problem?*
  - *Are there other ways? Can you think of them?*
  - *How can you be sure you have the correct solution?*
  - *Could there be more than one correct solution?*
  - *How can you convince me that your solution makes sense?*
- For effective development of mathematical understanding students should undertake tasks of inquiry, reasoning, and problem solving which are similar to real-world experiences.



- Learning is most effective when students are able to establish a connection between the activities within the classroom and real-world experiences.
- Activities, investigations, and projects which facilitate a deeper understanding of mathematics should be strongly encouraged as they promote inquiry, discovery, and mastery.
- Questions for teachers to consider when planning an investigation:
  - *Have I identified and defined the mathematical content of the investigation, activity, or project?*
  - *Have I carefully compared the network of ideas included in the curriculum with the students' knowledge?*
  - *Have I noted discrepancies, misunderstandings, and gaps in students' knowledge as well as evidence of learning?*

## Principle 2

All students have access to high quality mathematics programmes.

- Every student should be fairly represented in a classroom and be ensured access to resources.
- Students develop a sense of control of their future if a teacher is attentive to each student's ideas.

## Principle 3

Mathematics learning is a lifelong process that begins and continues in the home and extends to school, community settings, and professional life.

- The formation of mathematical ideas is a part of a natural process that accompanies pre-kindergarden students' experience of exploring the world and environment around them. Shape, size, position, and symmetry are ideas that can be understood by playing with toys that can be found in a child's playroom, for example, building blocks.
- Gathering and itemising objects such as stones, shells, toy cars, and erasers, leads to discovery of patterns and classification. At secondary level research data collection, for example, market reviews of the stock market and world economy, is an integral continued learning process. Within the environs of the classroom, projects and assignments can be set which help students relate new concepts to real-life situations.

## Principle 4

Mathematics instruction both connects with other disciplines and moves toward integration of mathematical domains.

An evaluation of maths textbooks considered two critical points. The first was, did the textbook include a variety of examples and applications at different levels so that students could proceed from simple to more complex problem-solving situations?

And the second was whether algebra and geometry were truly integrated rather than presented alternately.

- It is important to understand that students are always making connections between their mathematical understanding and other disciplines in addition to the connections with their world.
- An integrated approach to mathematics may include activities which combine sorting, measurement, estimation, and geometry. Such activities should be introduced at primary level.
- At secondary level, connections between algebra and geometry, ideas from discrete mathematics, statistics, and probability, establish connections between mathematics and life at home, at work, and in the community.

- What makes integration efforts successful is open communication between teachers. By observing each other and discussing individual students teachers improve the mathematics programme for students and support their own professional growth.

## Principle 5

Working together in teams and groups enhances mathematical learning, helps students communicate effectively, and develops social and mathematical skills.

- The Common Core of Learning suggests that teachers 'develop, test, and evaluate possible solutions'.
- Team work can be beneficial to students in many ways as it encourages them to interact with others and thus enhances self-assessment, exposes them to multiple strategies, and teaches them to be members of a collective workforce.
- Teachers should keep in mind the following considerations when dealing with a group of students:
  - *High expectations and standards should be established for all students, including those with gaps in their knowledge bases.*
  - *Students should be encouraged to achieve their highest potential in mathematics.*
  - *Students learn mathematics at different rates, and the interest of different students' in mathematics varies.*
- Support should be made available to students based on individual needs.
- Levels of mathematics and expectations should be kept high for all students.

## Principle 6

Mathematics assessment in the classroom is a multifaceted tool that monitors student performance, improves instruction, enhances learning, and encourages student self-reflection.

- An open-ended assessment facilitates multiple approaches to problems and creative expression of mathematical ideas.
- Portfolio assessments imply that teachers have worked with students to establish individual criteria for selecting work for placement in a portfolio and judging its merit.
- Using observation for assessment purposes serves as a reflection of a students' understanding of mathematics, and the strategies he/she commonly employs to solve problems and his/her learning style.

## Mathematical Practices

1. Make sense of problems and persevere in solving them.
2. Reason abstractly and quantitatively.
3. Construct viable arguments and critique the reasoning of others.
4. Use appropriate tools strategically.
5. Attend to precision and format.
6. Express regularity in repetitive reasoning.
7. Analyse mathematical relationships and use them to solve problems.
8. Apply and extend previous understanding of operations.
9. Use properties of operations to generate equivalent expressions.
10. Investigate, process, develop, and evaluate data.

## ▶ Lesson Planning

Before starting lesson planning, it is imperative to consider teaching and the art of teaching.

### FURL

**F**irst **U**nderstand by **R**elating to day-to-day routine, and then **L**earn. It is vital for teachers to relate fine teaching to real-life situations and routine.

'R' is re-teaching and revising, which of course falls under the supplementary/continuity category. Effective teaching stems from engaging every student in the classroom. This is only possible if you have a comprehensive lesson plan.

There are three integral facets to lesson planning: curriculum, instruction, and evaluation.

#### 1. Curriculum

A syllabus should pertain to the needs of the students and objectives of the school. It should be neither over-ambitious, nor lacking. (One of the major pitfalls in school curricula arises in planning of mathematics.)

#### 2. Instructions

Any method of instruction, for example verbal explanation, material aided explanation, or teach-by-asking can be used. The method adopted by the teacher reflects his/her skills. Experience alone does not work, as the most experienced teachers sometime adopt a short-sighted approach; the same could be said for beginner teachers. The best teacher is the one who works out a plan that is customised to the needs of the students, and only such a plan can succeed in achieving the desired objectives.

#### 3. Evaluation

The evaluation process should be treated as an integral teaching tool that tells the teachers how effective they have been in their attempt to teach the topic. No evaluation is just a test of student learning; it also assesses how well a teacher has taught.

Evaluation has to be an ongoing process; during the course of study formal teaching should be interspersed with thought-provoking questions, quizzes, assignments, and classwork.

### Long-term Lesson Plan

A long-term lesson plan extends over the entire term. Generally schools have coordinators to plan the big picture in the form of Core Syllabus and Unit Studies.

Core syllabi are the topics to be covered during a term. Two things which are very important during planning are the 'Time Frame' and the 'Prerequisites' of the students.

An experienced coordinator will know the depth of the topic and the ability of the students to grasp it in the assigned time frame.

### Suggested Unit Study Format

Weeks	Dates	Months	Days	Remarks

### Short-term Lesson Planning

A short-term plan is a day-to-day lesson plan, based on the sub-topics chosen from the long-term plan.

## Features of the Teaching Guide

The Teaching Guide contains the following features. The headings through which the teachers will be led are explained as follows.



### Specific Learning Objectives

Each topic is explained clearly by the author in the textbook with detailed explanation, supported by worked examples. The guide will define and highlight the objectives of the topic. It will also outline the learning outcomes and objectives.



### Suggested Time Frame

Timing is important in each of the lesson plans. The guide will provide a suggested time frame. However, every lesson is important in shaping the behavioural and learning patterns of the students. The teacher has the discretion to either extend or shorten the time frame as required.



### Prior Knowledge and Revision

It is important to highlight any background knowledge of the topic in question. The guide will identify concepts taught earlier or, in effect, revise the prior knowledge. Revision is essential, otherwise the students may not understand the topic fully.

The initial question when planning for a topic should be how much do the students already know about the topic? If it is an introductory lesson, then a preceding topic could be touched upon, which could lead on to the new topic. In the lesson plan, the teacher can note what prior knowledge the students have of the current topic.



### Real-life Application and Activities

Today's students are very proactive. The study of any topic, if not related to practical real-life, will not excite them. Their interest can easily be stimulated if we relate the topic at hand to real-life experiences. Activities and assignments will be suggested which will do just that.

Flash cards based on the concept being taught will have more impact.



### Summary of Key Facts

Facts and rules mentioned in the text are listed for quick reference.



### Frequently Made Mistakes

It is important to be aware of students' common misunderstandings of certain concepts. If the teacher is aware of these they can be easily rectified during the lessons. Such topical misconceptions are mentioned.



## Sample Lesson Plan

Planning your work and then implementing your plan are the building blocks of teaching. Teachers adopt different teaching methods/approaches to a topic.

A sample lesson plan is provided in every chapter as a preliminary structure that can be followed. A topic is selected and a lesson plan written under the following headings:

### Topic

This is the main topic/sub-topic.

### Specific Learning Objectives

This identifies the specific learning objective/s of the sub-topic being taught in that particular lesson.

### Suggested Duration

Suggested duration is the number of periods required to cover the topic. Generally, class dynamics vary from year to year, so flexibility is important.

The teacher should draw his/her own parameters, but can adjust the teaching time depending on the receptivity of the class to that topic. Note that introduction to a new topic takes longer, but familiar topics tend to take less time.

### Key vocabulary

List of mathematical words and terms related to the topic that may need to be pre-taught.

### Method and Strategy

This suggests how you could demonstrate, discuss, and explain a topic.

The introduction to the topic can be done through starter activities and recap of previous knowledge which can be linked to the current topic.

### Resources (Optional)

This section includes everyday objects and models, exercises given in the chapter, worksheets, assignments, and projects.

### Written Assignments

Finally, written assignments can be given for practice. It should be noted that classwork should comprise sums of all levels of difficulty, and once the teacher is sure that students are capable of independent work, homework should be handed out. For continuity, alternate sums from the exercises may be done as classwork and homework.

**Supplementary Work (Optional):** A project or assignment could be given. It could involve group work or individual research to complement and build on what students have already learnt in class.

The students will do the work at home and may present their findings in class.

### Evaluation

At the end of each sub-topic, practice exercises should be done. For further practice, the students can be given a practice worksheet or a comprehensive marked assessment.

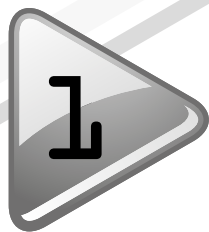

# Introduction to sets



## Specific Learning Objectives

- Concept of sets, how they are formed, what they consist of, and when they can be formed?
- The language of sets and the symbols denoted to represent each type, and specifications
- Concept of Venn diagrams and drawing them
- Different types of sets



## Suggested Time Frame

3 to 4 periods



## Prior Knowledge and Revision

Sets are being introduced for the first time. They do have prior knowledge of sets though, as multiplication is introduced in the form of grouping numbers as sets.

For example, 4 times 3 is taught as four sets of 3. These can be shown with the help of beads, bottle caps, stationery items, etc.

In earlier years students have seen Venn diagrams as lowest common multiple sets, where the multiples of two numbers are put in Venn diagrams with common values in the middle of the Venn diagram.

It is advised to mention the above facts when introducing sets, especially multiplication. This will create a link and connection to the chapter.

Any link with prior knowledge brings in continuity and connectivity.

For example, when introducing the topic of sets, ask students to group themselves in different sets of girls and boys and then within each set, make a separate set of those who wear glasses.

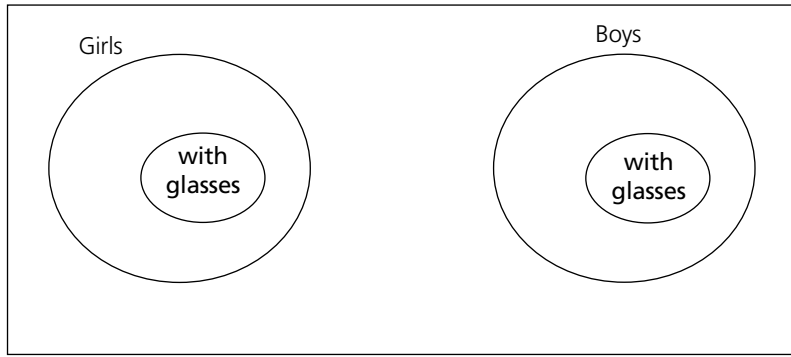

## Real-life Application and Activities

This chapter is an ideal starter to the syllabus, as students can be involved in activities. Assignments can be given which ask them to create their own Venn diagrams using their friends and family as elements.



## Summary of Key Facts

- Sets are collections of distinct objects. This fact can be elaborated with real-life objects like stationery items, people with preferences, fruits and vegetables, etc. Numbers can be brought in after the introduction of real-life examples.
- Elements are members of a set. Depending on the type of members, sets can be finite or infinite.
- Finite sets have a definite number of elements, but in infinite sets, elements can go on indefinitely.
- Sets can be described in two ways:
  - Descriptive notation: all elements are described in words without the curly brackets.
  - Tabular notation: all elements are mentioned within curly brackets, separated by commas.
- A unit set is a set that contains only one element.
- An empty set has no elements. It is denoted by  $\emptyset$ .
- Disjoint sets have no elements in common, hence do not overlap in a Venn diagram.

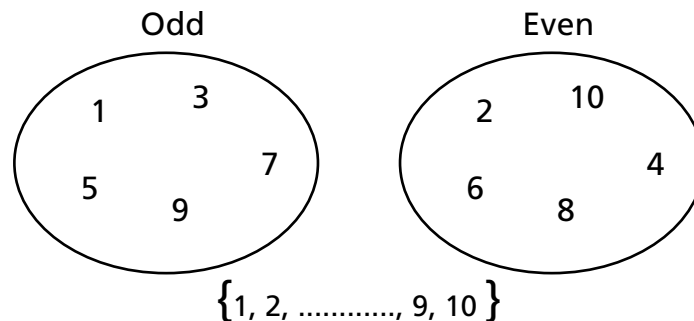

- Overlapping sets have some elements in common.

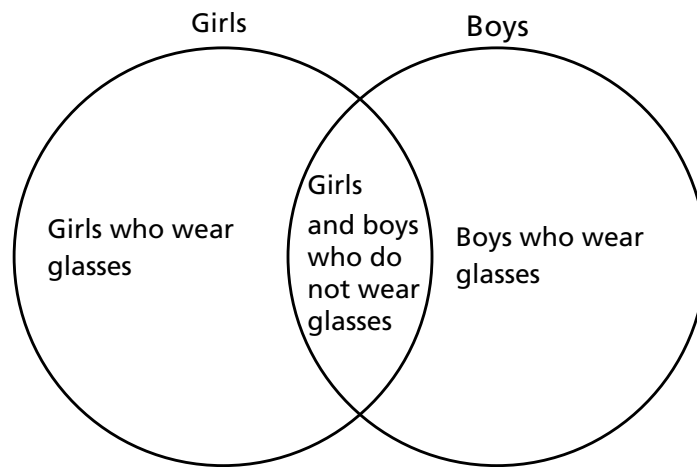

- Equivalent sets have same number of elements but do not have to have identical elements.
- Equal sets are sets which are identical in the number of elements and the elements themselves.
- A universal set is the main set with all the other sets as subsets. It is drawn as a rectangle.
- Subsets are sets that are part of the main set. This happens if one of the sets contains some elements of the main set.
- A proper subset has all the elements of the main set with at least one element more than the subset. It is denoted by the sign  $\subset$ .
- A subset that contains every element of the main set is called the improper subset. The improper subset and the main original set are equal.
- A super set is a set that contains all the elements of a smaller set.
- A power set contains all the possible subsets of the main set. In other words, the number of sets that can be permuted out of the main set.
- The cardinality of a set states the number of elements contained in a set. It is denoted by the letter  $n$ .
- Correspondence between sets is achieved when one-to-one pairing between elements of two sets happens.



## Frequently Made Mistakes

Sets are considered to be associated with Venn diagrams only, not realising that the Venn diagram is just a depiction tool. The study of sets has to be treated later as day-to-day real-life situations. Therefore this should be treated as a branch of mathematics that is like arithmetic story sums, but with different depiction.





## Sample Lesson Plan

### Topic:

Sets

### Specific Learning Objectives

Finite and infinite sets, subsets, and proper subsets.

### Suggested Duration:

1 period

### Key Vocabulary

Set, Element, Finite, Infinite, Venn diagram, Universal set, Subset, Proper subset

### Method and Strategy

#### Activity

Sets should be introduced with a 5-minute brainstorming quiz to create as many finite and infinite sets as possible. For example, planets of our galaxy, stars in the universe, prime numbers, multiples of 3 less than 20, etc. Students should be encouraged to suggest elements and types of sets.

A group quiz can be created where flash cards of different types of sets can be named and each member of every group picks a card and gives an example of the type of set named on the card. To clarify the difference between subsets and proper subsets, pick two students. Give one of them three pencils and the other 5, of which 3 are identical to those of the first student.

### Written Assignments

Exercises 1a and 1b can be done as an oral quiz in class. Many more examples can be created with students.

Exercises 1c and 1d can be given as an assignment to be done on chart paper.

Exercise 1e can be done as classwork and homework. In one period all even-numbered sums can be done. Odd-numbered sums can be given as homework. Test paper 1 can be done in class as a marked assignment prior to a formal assessment test. This is a comprehensive review and any misconceptions formed can easily be clarified by the teacher during its correction.

### Evaluation

A similar worksheet can be made by the teacher, by changing the numbers in sums from test 1, or by taking other examples.

It would be interesting if the teacher used the names of the students in the class and their characteristics as descriptive and tabular notations.

### After completing this chapter, students should be able to:

- define sets and the different features of a set,
- identify and write sets in descriptive, tabular, and set builder notation,
- illustrate sets by drawing Venn diagrams, and
- define and express different types of sets.



# Natural Numbers and Whole Numbers



## Specific Learning Objectives

- Place value in both the Pakistani and international systems of numeration
- Whole numbers, natural numbers, and their commutative, associative, and distributive properties
- The use of a number line and converting exponential to expanded notation



## Suggested Time Frame

2 to 3 periods



## Prior Knowledge and Revision

The teacher should conduct a quick review of place value where the students recognise a digit and its place value and call out an answer.

### *Example*

2 4 6 7 8

Circle 2 and ask for its place value, then 8, and then skip to 4.

A revision quiz can be held. This should not take more than a minute.

Revision of the use of a number line on the board along with the four operations should take 5 minutes. Odd, even, prime, and composite numbers can be identified on the number line.



## Real-life Application and Activities

### Starter activity

In Grade 6 we can discuss the importance of numbers and use clippings brought in from the business pages. Students can research, for example, the distance of the Earth from the Moon or the distance from Karachi to Chicago. A comparison of the population of Karachi and that of Faisalabad can also be done. Interestingly, they can do all the operations using population as the topic.

### Examples

- How many times is the population of Karachi bigger than the population of Edinburgh? They can Google the populations and then proceed.
- What is the difference between the population of Karachi and that of Islamabad?
- If a spaceship takes 3 days to circumnavigate a planet three times and covers a distance of 40,075 km, how long will it take to go around it ten times?

### Activities

Students should be asked to display the tables given on page 27 of the textbook on the display board.

A game of shape! can be played by pairs of students, where the teacher can prepare flash cards of Pakistani and international numeration. Shuffle the cards and give each student one set of numeration card in words or in numbers. The moment a student recognises he/she has the matching numeration, he/she can call out, 'snap!'

A game of bingo can also be played.

43567	78956	54098	23438
67859	23405	56843	37501

Cards as shown above should be prepared with different set of numbers and handed to students. The teacher should call out these numbers shuffled with another set of eight numbers.

The teacher should call out the number in Pakistani or international numeration and the child has to recognise the number and cross it out. The one who crosses out all the numbers first shouts, 'BINGO!.' The teacher should check the answers and award a point.

This is a very enjoyable 3-minute activity.



### Summary of Key Facts

- Natural numbers are a set of infinite numbers beginning from one.
- Odd and even numbers are subsets of natural numbers.
- Whole numbers are all natural numbers, including zero. It is an infinite set.
- Natural numbers are a subset of whole numbers.
- Zero can be divided by any number but it cannot divide any number. The identity of a number does not change when added to or subtracted from a number. Multiplication by zero results in zero.

#### Example:

$\frac{4}{0}$  is undefined, while  $\frac{0}{4}$  gives an answer of zero.

- When the number one divides or multiplies, the identity of the number remains unchanged.
- Commutative property of addition: the sum of two whole numbers remains unchanged even if the numbers interchange their places.
- Commutative property of multiplication: the product of two whole numbers remains unchanged even if the numbers interchange their places.
- Associated property of addition: the sum of three numbers taken in a particular order does not change if the grouping of the numbers is altered.

- Associative property of multiplication: the product of three numbers, however they are ordered will result in the same product.
- Distributive property of multiplication over addition: in a sum involving the operations of addition and multiplication the answer remains unchanged if we work the brackets first or multiply the numbers inside the brackets individually.

**Example:**

$$7 (5 + 3) = 7 (8) = 56$$

$$7 \times 5 + 7 \times 3 = 35 + 21 = 56$$

- Pakistani system of numeration: this system, after the first period, which consists of three digits (units, tens and hundreds), has all periods in twos. The thousands, lacs, crores, and arabs all have two digits each.
- International system of numeration: this system has periods in threes. Use of commas should be encouraged so the students are able to differentiate between the units, tens, hundreds, thousands, millions, and billions periods easily.



## Frequently Made Mistakes

Students get confused while drawing the number line and making the arrows move forward or backwards. Lots of quizzes should be done on the board to show the properties (commutative, associative and distributive).

If the use of commas is encouraged in place value numeration, students will not face problems in converting from the Pakistani to international numeration system and vice versa.



## Sample Lesson Plan

### Topic

Comparison between Pakistani and international numeration systems

### Specific Learning Objectives

Differentiating between the Pakistani and International numeration system by working simultaneously with both.

### Suggested Duration

1 period

### Key Vocabulary

Units, Tens, Hundreds, Thousands, Ten thousands, Hundred thousands, Lacs, Ten lacs, Crores, Ten crores, arab, Million, Ten millions, Billions

## Method and Strategy

### Pakistani System of Numeration

Arab, Ten Crore, Crore, Ten Lac, Lac, Ten thousand, Thousand, Hundred, Ten, Unit

### International System of Numeration

Billion, Hundred million, Ten million, Million, Hundred thousand, Ten thousand, Thousand, Hundred, Ten, Unit

The periods for Pakistani and international place values are different; these are denoted by commas. This will enable the students to differentiate between the two systems easily and they will be able to express a set of numbers according to their place value in two different ways.

#### Example

- 4,56,78,034: four crore, fifty-six lac, seventy-eight thousand, and thirty-four OR
- 45,678,034: forty-five million, six hundred and seventy-eight thousand, and thirty-four

#### Activity

An activity to place commas for the for Pakistani and international systems of numeration could be done for 10 minutes as an oral quiz in the lesson. The students can be divided into groups and marks awarded for correct answers.

Expanded notation can be explained with the help of a place-value table.

#### Example

2 4 5, 6 7 8

HTh TTh Th, HTU

2 4 5, 6 7 8

2 0 0, 0 0 0 (2 is in the hundred thousands place)

4 0, 0 0 0 (4 is in the ten thousands place)

5, 0 0 0 (5 is in the thousands place)

6 0 0 (6 is in the hundreds place)

7 0 (7 is in the tens place)

8 (8 is in the units place)

To check, ask the students to add vertically and see if they get the given number.

200,000

40,000

5,000

600

70

+ 8

245,678

The placement of commas and rewriting of numbers in expanded notation on the board helps the student to understand the numbers better. It is better that they write every given number in both types of numeration simultaneously.

## Written Assignments

The following exercise can be done in class with alternate sums to be done for homework.

Write in words the following numbers, first in the Pakistani and then in international numeration system.

- |             |            |            |            |            |
|-------------|------------|------------|------------|------------|
| a) 54734645 | b) 3450465 | c) 9870567 | d) 9073452 | e) 5673208 |
| f) 3867034  | g) 6781234 | h) 5008769 | i) 2453789 | j) 1007893 |

Check the five classwork sums by calling out the answers; students can do peer checking along with corrections in class. This will help them in their homework.

## Evaluation

A quiz for both the exercises can be held in class. This will act as a diagnostic assessment. The teacher can gauge if more practice is needed in place value or in learning the different properties of numbers.

### After completing this chapter, students should be able to:

- distinguish between natural and whole numbers,
- add, subtract, multiply, and divide natural and whole numbers,
- use the number ray and number line to perform arithmetic operations,
- apply the commutative, associative, and distributive properties to solve arithmetic problems, and
- convert numbers from exponential notation to expanded notation, and vice versa.



# Factors and Multiples



## Specific Learning Objectives

- Factors and multiples
- Test of divisibility
- Prime and composite numbers



## Suggested Time Frame

2 to 3 periods



## Prior Knowledge and Revision

Before introducing factors and multiples the teacher should revise the multiplications tables and how the product is the multiple of a particular number and the multiplicands are the factors of the product.

### *Example:*

3 times 7 are 21, where 21 is the product, and therefore the multiple. 3 and 7 are the multiplicands and thus the factors of 21.

For the test of divisibility, the teacher can talk about numbers ending with even numbers, (i.e. 0, 2, 4, 6 and 8) and point out that they are completely divisible by 2. Similarly, numbers ending with 5 or zero are completely divisible by 5.



## Real-life Application and Activities

The students can be introduced to sequencing and arrangements. For example, and the teacher can spot tiles on the floor and say that every fifth square is coloured or different which means that the arrangement is in multiples of 5 (or any other arrangement that can be pointed out). If each period is of 30 minutes, the teacher can point out that the bell rings every 30 minutes so it is an arrangement of 30s.

## Starter Activity

The students can participate in a mental maths quiz of multiples where flash cards of multiples of 3s, 5s, and 6s or any other set, are prepared. The teacher calls out a number, for example, 3. Students start looking through the flash cards until they find a multiple of 3 and shout 'BINGO!'. Repeat this for other numbers too. This mental maths activity sharpens the skill to identify multiples and will only take a minute or two.

## Activity

The difference between multiples and factors has to be made clear. The fact that factors form finite sets and multiples form infinite sets is important.

Groups of students can be given cards with numbers from 1 to 50. The teacher can ask the students to sort them into two sets of multiples, for example, those of 3 and 7, and then shuffle them and quickly line up the factors of say 21 or 28. The group that completes the activity first is given a point; this can be repeated for different numbers.



## Summary of Key Facts

- A number that completely divides a number is a factor.
- A multiple is obtained when a number is multiplied by a natural number.
- Even numbers are exactly divisible by 2 without a remainder.
- A number not completely divisible by 2 is an odd number.
- A prime number has only two factors, itself and 1.
- A composite number has more than two factors.
- Two prime numbers with a difference of 2 are called twin-prime numbers.
- Two numbers whose HCF is 1, are called co-prime numbers.
- A set of three successive prime numbers with a difference of two are called a prime triplet.
- There are specific tests whereby one can check if a number completely divides another. These are called tests of divisibility.



## Frequently Made Mistakes

The most common mistake is that students think that '1' is a prime number. If this mistake is not corrected at the beginning, they will face problems in solving sums involving multiples and factors.





## Sample Lesson Plan

### Topic

Prime numbers

### Specific Learning Objectives

Understanding prime numbers

### Suggested Duration

1 period

### Key Vocabulary

Composite number, prime number.

### Method and Strategy

Students know the definition of prime numbers. When explaining factors, composite numbers and prime numbers, the teacher should make clear the difference between them.

In order to find HCF and LCM by the long division method, prime numbers are used.

Take a vinyl sheet of 120 cm by 120 cm and use electric tape to make ten columns and ten rows on it. Use a permanent marker to write numbers 1 to 100 in the spaces formed. Place it on the floor of the classroom and ask the students to stand around it.

Use plain flash cards of the same size as each number box.

Follow the steps on page 41 of the textbook.

Start excluding the composite numbers one-by-one by placing a flash card over them to block them from view.

After the fifth step, the sieve reveals all the prime numbers between 1 and 100.

Ask the students to note them in their notebooks.

### Written Assignments

Co-prime numbers are prime numbers with a difference of two between them.

Ask students to list as many sets as possible in their notebooks from the prime numbers between 1 and 100.

### Evaluation

An assessment can be conducted with multiple choice questions and definitions.

Sums on page 77 and 78 and questions 11 to 17 of the revision exercise can be used to form an assessment to assess the students' learning.

### After completing this chapter, students should be able to:

- find the factors and multiples of given numbers,
- apply the rules to test the divisibility of numbers, and
- distinguish between prime numbers and composite numbers.

## 4

# Factorization: HCF and LCM



## Specific Learning Objectives

- Finding HCF by prime factor method and division method
- Finding LCM by prime factor method and division method
- Understanding the concepts of prime factorization and co-prime numbers



## Suggested Time Frame

4 to 5 periods



## Prior Knowledge and Revision

The difference between factors and multiples has already been explained in the earlier chapter. There is no need for quizzes or activities, as it is a continuation of the earlier topic.



## Real-life Application and Activities

Prime factorization is like a tree with branches. Factor trees are easy to make on soft-boards. Students can also build such factor trees with real trees in the playground with numbers hanging from the branches as prime factors. The students enjoy breaking down a number up into its factors.

It is the breaking down of composite numbers into their prime factors.

### Example

$$\begin{array}{l}
 120 \\
 / \quad \backslash \\
 2 \times 60 \\
 \quad / \quad \backslash \\
 2 \times 2 \times 30 \\
 \qquad \quad / \quad \backslash \\
 2 \times 2 \times 2 \times 15 \\
 \qquad \qquad \quad / \quad \backslash \\
 2 \times 2 \times 2 \times 3 \times 5
 \end{array}$$

Factors of 120 are:  $2 \times 2 \times 2 \times 3 \times 5$  or  $2^3 \times 3 \times 5$

The students should understand that they need to continue with breaking down the composite factors till they cannot be broken down any further. Another point to emphasise is the prime index, that is, if the same factor occurs more than once, powers should be introduced.

HCF AND LCM both require the composite number to be broken down and then the HCF is found by circling the smaller common numbers and the LCM is found by circling the largest common powered factor and the uncommon numbers.

**Example**

Find the LCM and HCF of 42, 48, and 54.

2	42, 48, 54
2	21, 24, 27
2	21, 12, 27
2	21, 6, 27
3	21, 3, 27
3	7, 1, 9
3	7, 1, 3
7	7, 1, 1
	1, 1, 1

2	42, 48, 54
3	21, 24, 27
	7, 8, 9

$$\text{HCF} = 2 \times 3 = 6$$

$$\text{LCM} = 2^4 \times 3^3 \times 7 = 3024$$

**Example**

Find the HCF and LCM of 36 and 54.

$$\text{Factors of } 36 = 2^2 \times 3^2$$

$$\text{Factors of } 54 = 2 \times 3^3$$

$$\text{HCF} = 2 \times 3^2 = 18$$

$$\text{LCM} = 2^2 \times 3^3 = 108$$

Find both the HCF and LCM as a quiz on the board. Divide the students into 3 groups and ask them to solve the questions simultaneously.

Discuss real-life applications; LCM is associated with buses coming to the station at regular intervals and the first common time for the arrival of two buses would be the LCM of their interval times. Similarly, given two containers of different capacities you can find one which contains both of their maximum capacity. This can be practically done by bringing containers in the classroom. Do examples 6 and 7 in class. Example 6 requires a measuring tape and threads measuring 360 cm and 840 cm and 120 cm.



## Summary of Key Facts

While doing the division method, consider the following points.

- Use only prime numbers while dividing.
- Divide all the numbers if possible in every step.
- Bring the numbers down if not divisible.
- Continue dividing till you have ones left.
- Use test of divisibility to figure out the factors.
- Relationship between HCF and LCM: The product of the HCF and LCM of two numbers is the same as the product of the two numbers.



## Frequently Made Mistakes

Students make mistakes in finding the prime factors as they are not quick at using the test of divisibility. Also, when using the prime factorization and division methods, they get confused in the selection of common and uncommon factors to find the HCF and LCM. It is important to calculate the HCF and LCM of numbers together once both have been introduced.



## Sample Lesson Plan

### Topic

HCF and LCM

### Specific Learning Objectives

Finding the relationship between HCF and LCM of two numbers.

### Suggested Duration

1 period

### Key Vocabulary

Factors, Prime factors, Highest Common Factor, Multiples, Lowest Common Multiple, Long division method

### Method and Strategy

### Activity

Ask the students to find the HCF and LCM of two numbers. Ask them to multiply the two numbers and also multiply the HCF and LCM of these numbers. The students will discover that both the products are the same. The first student to work out the sum and discover this fact should be applauded.

## Written Assignments

Students can do Q # 11 to 14 of Exercise 4b as classwork.

A similar assignment can be done for homework where they find the HCF and LCM of five pairs of numbers and prove this relationship by finding the products and equating them. The students should be encouraged to select their own pairs of numbers.

## Evaluation

A five minute quiz at the beginning of every lesson on the topic previously taught can be given. For example, in the second lesson students can be asked to make the factor tree of 56 and 124 and find the HCF.

Homework and class assignments may be marked and points awarded, for correct proofs.

## After completing this chapter, students should be able to:

- find the prime factors of a given number,
- find the HCF of two or more numbers by prime factorization and long division methods,
- find the LCM of two or more numbers by prime factorization and long division methods, and
- solve real-life problems based on HCF and LCM.



# Integers



## Specific Learning Objectives

- Integers and their ordering
- All the operations involving integers
- Differentiating between natural and whole numbers, and negative and positive integers



## Suggested Time Frame

2 to 3 periods



## Prior Knowledge and Revision

Students are familiar with whole numbers and natural numbers and understand their commutative, associative, and distributive properties.

### RECALL

The students could be asked to revise the rules of BODMAS. If not introduced earlier, explain it in the following way.

B is for brackets.

O is for order (exponents / power, square root, cube root).

D is for division.

M is for multiplication.

A is for addition.

S is for subtraction.

The order of the operations is set by this rule.

There are three types of brackets and they are to be written in the order given below:

box brackets [ ], curly brackets { }, and parenthesis ( )

[ { ( ) } ]

The content of the innermost brackets is attempted first.

### Example

$$\{[17 + (6 - 3)] \div 10\}$$

Solve the round brackets first,

$$\{[17 + 3] \div 10\}$$

then the curly brackets,

$$[20 \div 10]$$

and lastly the box brackets.

2

### Starter Activity

A fun game can be played. Students are divided into pairs and handed a set of flash cards and a dice. Each number on the dice can be assigned an operation.

If a student gets a 6, the operation can be addition, or so on.

They have to roll the dice and pick out two flash cards and apply the operation. They get 2 minutes to take as many turns and note the numbers and answer. The pair that gets the most correct answers wins.

Use only three operations addition, subtraction and multiplication in the game.

At this stage teacher can point out that addition and subtraction of integers can be done on a number line.

### Example

$$5 - 7 = -2$$

Draw the number line on the board and point out that as you are moving 7 steps to the left from 5, the answer comes to  $-2$ .

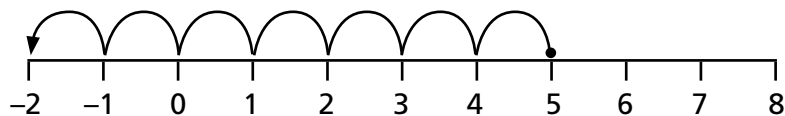

## Real-life Application and Activities

When introducing the number line, the teacher should stress that there are infinite numbers continuing at both ends of the number line. To explain infinity he/she can relate it to the galaxies and universe and the beginning and end of time.

When dealing with negative integers he/she can give an example of temperature: when it gets very cold in the northern regions, the temperature goes below zero to acquire negative values. Similarly, it can be pointed out that in a bank balance, credit and debt are respectively plus and minus amounts, and sometimes we overdraw and end up with a negative balance. Profit and loss can also be mentioned.

### Examples:

- The temperature in Kashmir in January fell below zero to  $-5\text{ }^{\circ}\text{C}$ .
- If the balance of my account is minus Rs 5000, I owe the bank Rs 5000.
- A lot of quizzes can be given by drawing a number line on the board and asking questions. The students can do a group activity in which they can draw a timeline for the Greeks and Romans on chart paper. The concepts of CE and BCE can be related to positive and negative numbers respectively.



## Summary of Key Facts

- Integers form an infinite series of numbers, both positive and negative.
- The sum of two integers remains unchanged if they interchange their places. This is the commutative property of integers.
- The associative property of addition of integers states that for three or more integers their order of addition need not be the same to get the same result.
- The additive identity of integers: the zero does not alter the sum. The integer value remains the same.
- The additive inverse is the fact that for every number there is an inverse such that the sum of a number and its inverse is zero.
- The closure property of multiplication of integers states that the product of two integers (positive or negative) will always be an integer value.
- The commutative property of multiplication of integers states that regardless of the order, the product of two integers remains the same.
- The associative property of multiplication of integers states that regardless of the order, the product of three integers remains the same.
- The multiplicative identity of integers states that the product of 1 and any integer will always be the integer itself.
- The multiplicative inverse means that every integer other than zero has an inverse reciprocal that will always result in the product of one when multiplied with the integer.
- The distributive property of multiplication over addition states the product of the first integer and the sum of the other two is equal to the sum of the product of the first and the second and the product of the first and the third.



## Frequently Made Mistakes

Students tend to get confused when dealing with negative integers. The fact that two negatives give a positive product and a negative and a positive integer give a negative product has to be taught with a lot of oral work.





## Sample Lesson Plan

### Topic

Integers

### Specific Learning Objectives

Multiplying numbers using rules

### Suggested Duration

1 Period

### Key Vocabulary

Positive and negative integer, Product, Multiplicand, Multiplier

### Method and Strategy

#### Activity

Students should know that the product of two positive integers will always be positive. Likewise, the product of two negative integers will also be positive. Only when a negative and a positive integer are multiplied is the product negative.

These facts can be enhanced by playing a five minutes game.

Students are given a set of jumbled numbers on the board. On the other half of the board there is a set of jumbled answers.

The teacher calls out a question by choosing numbers written on the board. For example, what is  $4 \times (-4)$ ? The students have to spot the answer and highlight it.

The group that highlights the most correct answers in a time limit of 30 seconds wins.

### Written Assignments

Q # 8 and 9 of Exercise 5b and similar sums can be given for classwork and homework .

### Evaluation

Exercises 5a and 5b should be divided into classwork and homework assignment. Alternate sums can be given for each assignment.

Quizzes should be given in each class to check if the students have learnt and understood the rules of operations.

An assessment should be given at the end of the topic. It should consist of all types of sums involving the properties of addition, subtraction, multiplication, and division.

The sums of Exercises 5a and 5b can be altered by changing the numbers to form the test.

### After completing this chapter, students should be able to:

- distinguish between integers, whole numbers, and natural numbers,
- add, subtract, multiply, and divide integers using rules, and
- apply the commutative, associative, and distributive properties to solve arithmetical problems involving integers



# Ratio and Proportion



## Specific Learning Objectives

- What is meant by ratio and proportion
- Expressing ratios in the simplest form
- Comparing ratios of different terms
- Differentiating between direct and inverse proportion



## Suggested Time Frame

4 to 5 periods



## Prior Knowledge and Revision

Students have been doing rate questions from earlier levels where they were asked to calculate the value of multiple values if the value of one is given. They have also learnt about equivalent fractions and comparing fractions.

A small oral quiz can be held in class to introduce the chapter in which short questions on these topics can be asked. The teacher should congratulate those who give quick, accurate answers.



## Real-life Application and Activities

During the introduction of the topic, the teacher can give the students some short survey assignments.

### Starter Activity

- Ratio of the weights of two students
- Ratio of the number of students in Grade 6 and Grade 7
- Ratio of amounts of money spent by two students in lunch break

## Topic Activity

The teacher can choose to do a baking activity in school or ask students to do it at home under adult supervision.

The recipe to make cookies requires:

100 gm of flour,

50 gm of sugar,

1 teaspoon of baking powder, and

2 tablespoons of butter.

This recipe is enough for ten cookies. Ask the students to make 30 cookies. In order to do so, they will have to multiply all proportions by 3.

It should be emphasised that the ingredients are in a ratio to each other and that they were proportionally increased.



## Summary of Key Facts

- Ratios are a comparison of two values having the same unit.
- Ratios can never be expressed as fractions or decimals; they need to be converted to whole numbers.
- They are always expressed in their simplest form and the new value is expressed before the old value.
- When two ratios are equivalent, they constitute a proportion.
- Three quantities of the same proportion are in the form of continued proportion as the ratio of the first to the second is equal to the ratio of the second to the third.
- The cross product rule states that the product of the two extremes is equal to the product of the means.
- Direct proportion involves two sets of values that are linked by the fact that if one value increases, the second value also increases, or vice versa.
- Inverse proportion involves the fact that if one value increases, the other value subsequently decreases, or vice versa.



## Frequently Made Mistakes

Students understand the concept of ratios being fractions but tend not to link it properly to the fact that just like fractions, the values should have the same unit and property.

### *Examples*

You cannot form a ratio of weight of one student to the height of the other.

Similarly, students tend to forget conversion of the units. For example, the weight of Ali in kg can not be compared to the weight of Sara in pounds.

Sometimes, they overlook the fact that ratios have to be in the simplest form and need to be reduced.

For example, 6 : 10 is actually 3 : 5.



## Sample Lesson Plan

### Topic

Inverse proportion

### Suggested Duration

1 period

### Specific Learning Objectives

### Key Vocabulary

Ratios, Direct proportion, Inverse proportion

### Method and Strategy

#### Activity

The concept of the relationship of two quantities that indirectly affect each other should be explained. The students should first be taught to differentiate between direct and inverse proportions and then the format and method can be explained. If they cannot differentiate between direct and inverse proportions, they will not be able to select the correct format.

A class activity can be done where the teacher writes on the board a few examples such as:

- diameter of the pipes and the time it takes to fill up a tank,
- the number of days the food will last and the number of cattle,
- the speed of the car and the time it takes to finish the journey, and/or
- the number of days to finish a piece of work and the number of workers.

Pictures of these situations can be displayed on the board. Students could be asked to illustrate a suitable example and give a presentation.

This will help students to distinguish between increasing and decreasing relationships.

After this activity the teacher can explain the method of working out inverse ratios.

### Written Assignment

Exercise 6b can be done in class.

Worksheets can be made with mixed sums of direct and inverse proportion and students can first differentiate between the two concepts and then solve them.

### Evaluation

In each lesson a quiz of five sums can be given to check whether the students are making conceptual errors. In this topic they tend to make careless errors too. Once sure that the students are on board and understand the concept of ratios, the teacher can proceed. At the end of the chapter, a combined assessment of all concepts taught should be given to ensure that the students understand all the concepts fully.

**After completing this chapter, students should be able to:**

- express the relationship between two quantities in the form of a ratio,
- express a ratio as a fraction,
- convert a ratio into its simplest form,
- compare ratios,
- find the missing value in a proportion by applying the cross product rule, and
- solve real-life problems involving direct and inverse proportion.



# Financial Arithmetic



## Specific Learning Objectives

- Unitary method of calculating values
- Calculations involving percentages
- Profit and loss
- Simple interest and method of calculating it



## Suggested Time Frame

This is a very important topic; basic percentages and arithmetic calculations will be time consuming. At least 8 to 10 periods should be assigned to this chapter.



## Prior Knowledge and Revision

Brainstorming session on percentages can be done. The teacher and should be reminded that per cent means out of 100. In order to find the percentage of a value, it has to be multiplied by 100. Similarly, if a percentage has to be converted to a fraction or decimal, it has to be divided by 100.



## Real-life Application and Activities

Relating mathematics to real-life situations is easy when teaching this topic. The teacher can give the students a shopping list as an activity.

### Example

Items	Shopping List	Price List
1	5 packets of orange juice	3 packets of orange juice cost Rs 60
2	10 cans of beans	2 cans of beans cost Rs 200
3	12 packets of potato chips	5 packets of potato chips cost Rs 150

The students should be asked to find the individual value of each item and then calculate the total cost.

The teacher can then ask them to go to the supermarket with their parents and bring in the receipt. The students can then swap the receipts and use them to create their own word problems. The teacher can bring in advertisements from newspapers and magazines to show them various offers.

### *Example*

## **Bumper sale**

**3 packets of biscuits for the price of two OR**

**BUY ONE GET ONE FREE**

These practical examples will help them relate to and connect with the topic better. Students could even be encouraged to manage their pocket money and create a ledger of their savings and expenditure for a week.



## **Summary of Key Facts**

- Percentage is a derivative of the Latin *per centum*.
- When the selling price is more than the cost price, one makes a profit.
- When the cost price is more than the selling price, one incurs a loss.
- Simple interest is the amount of money accrued over a certain period of time when a certain amount is invested or borrowed.
- The principal is the amount of money invested or borrowed on which the simple interest is accrued.
- The rate of interest is a percentage generally applied to the principal amount for a period of a year.
- The time is the number of years or months over which the simple interest is calculated.



## **Frequently Made Mistakes**

Students get confused when calculating profit and loss percentages. It must be explained that percentages are a ratio of the subject to the original or total amount multiplied by 100%; that is, profit over the cost price multiplied by 100%, or loss over cost price multiplied by 100%.

Everyday story sums where they have to find the rate of one value, get multiple values as answers, and then find the total causes some confusion. If they are taught to write the data clearly and solve the question step by step, they will avoid such errors.



## Sample Lesson Plan

### Topic

Simple interest

### Specific Learning Objectives

Concept of simple interest and application of the formula

### Suggested Duration

1 period

### Key Vocabulary

Simple interest, Principal, Amount, Time, Rate

### Method and Strategy

#### Activity

The students should be divided into two groups for class quizzes. One volunteer is nominated from each group.

The board is divided into halves.

Each part of Q # 1 of Exercise 7d is written by the teacher on both halves.

The student who works out the correct answer first is awarded a point. Points are deducted if he/she fails to write the data correctly. Groups will be encouraged to point out each other's mistakes.

#### Written Assignments

One part each of Q # 2 and 3 of Exercise 7d is done by the teacher and then students should be encouraged to complete the other parts.

Q # 4, 5, and 6 of Exercise 7d can be given for homework.

### Evaluation

Since this a lengthy topic, the evaluation can be carried out in two stages. The topics can be divided into two assessments that can be completed during the course of this chapter.

#### After completing this chapter, students should be able to:

- convert a fraction into a percentage and vice versa,
- calculate the profit or loss on a transaction,
- calculate the percentage of profit or loss on a transaction,
- calculate simple interest on a transaction, and
- solve real-life problems based on percentage, profit, loss, and simple interest.





# Introduction to Algebra



## Specific Learning Objectives

- Mathematical statements
- Variables and their functions in an algebraic expression
- Formulation of algebraic equations
- Adding, subtracting, simplifying, and evaluating algebraic expressions and equations



## Suggested Time Frame

This is a new topic; at least 4 to 6 periods should be assigned to it.



## Prior Knowledge and Revision

Students are being introduced to this branch of mathematics; they have no prior knowledge of algebra. However, the teacher can introduce a game where instead of adding just numbers, we assign letters to the subjects being added.

### *Example*

Let's assign 'p' for potatoes and 'q' for oranges, so to get the sum of 3 potatoes and 5 oranges the answer would be:  $3p + 5q$ .

The teacher can talk about Egyptian hieroglyphs and ancient languages which used symbols, so we can consider algebra to be a language of mathematics.



## Real-life Application and Activities

The teacher can ask the students to research various ancient languages and their symbols.



## Summary of Key Facts

- Variables represent quantities.
- A coefficient is the number in front of the variable; it expresses the number of the quantity.
- A constant is a number without a variable.
- Algebraic terms constitute variables, coefficients, and constants. They are made up of a collection of like and unlike variables and thus called like and unlike terms.

### *Example*

$$4x + 3y + 7$$

4 and 3 are coefficients,

$x$  and  $y$  are variables, and

7 is the constant.

- Like terms can be added or subtracted. Unlike terms cannot be added or subtracted.

### *Example*

$4xy$  and  $5xy$  are like terms, hence they can be added:  $4xy + 5xy = 9xy$ .

$4x$  and  $5y$  are unlike terms and cannot be added or subtracted.

- The BODMAS rule should be applied when simplifying terms and the brackets ( ), { }, [ ] in algebra. The vinculum  $\overline{(a + b)}$  has a horizontal bar above the term, and has to be attempted before the brackets.
- Laws of integers taught in the earlier chapter using the number line are also applicable when simplifying algebraic expressions.



## Frequently Made Mistakes

When adding or subtracting terms, students are confused by the signs, and sometimes forget to change the sign of the entire expression when subtracting terms. Rules of the signs have to be learnt.

Students tend to have no difficulty with the order of operations (BODMAS) but sometimes get confused with the order of the brackets.



## Sample Lesson Plan

### Topic

Algebra

### Specific Learning Objectives

Adding and subtracting like and unlike terms

### Suggested Duration

1 period

### Key Vocabulary

Variable, Coefficient, Constants, Like and unlike terms

### Method and Strategy

#### Activity

This chapter is all about practice. Lots of timed worksheets could be given for which the students can set their own time limits and see how many sums they can do in a minute.

The teacher writes twenty sums on the board or hands students a worksheet. She/he calls out the time and the students begin; after a minute she/he asks them to stop. Answers are reviewed by peer checking and the student with most correct answers is awarded a point.

### Written Assignments

Q # 1, 2, and 3 of Exercise 8b can be done in class. Remaining sums are given as homework.

### Evaluation

The students enjoy this topic. A lot of mini-tests can be given during the course of the chapter. A big assessment can be completed after the next chapter. Assessing the students with a short quiz in each lesson is important. This will help the teacher to gauge whether he/she needs to move ahead or spend more time on current topics.

### After completing this chapter, students should be able to:

- write an algebraic expression for a statement,
- differentiate between an algebraic equation and an algebraic expression,
- add and subtract algebraic expressions,
- simplify an algebraic expression, and
- evaluate an algebraic expression.



# 9

# Linear Equations



## Specific Learning Objectives

- Algebraic equations
- Structure and construction of algebraic equations
- Solution of algebraic equations

## Suggested Time Frame

4 periods



## Prior Knowledge and Revision

Students have been introduced to algebraic terminology and the simplification process along with rules of the operations. Revision as such is not needed as it's a continuation of, and directly linked to Chapter 8.



## Real-life Application and Activities

The word problems can be done as real-life situations where equations can be constructed for students and their situations.

### *Example*

If Ali is a student in the class and he has a sister Myra 12 years younger than him then, an equation relating their ages can be formed.

Denote Ali by  $x$  and Myra by  $y$ .

$$x - 12 = y$$

Or  $x = y + 12$

Similar situations of students can be used and various characteristics (age, height, number of absentees in a class, etc.) can be used to form equations.

Bring a weighing balance to class to explain the concept of equilibrium and hence, equations.



## Summary of Key Facts

- In an algebraic equation, the left hand side terms equal the right hand side terms.

### Example

$$4x + 7 = 11$$

This means that the value of  $x = 1$ .

Transposing is when a plus sign transposes or goes to the other side as a minus sign.

- The coefficient of the variable goes to the other side as the denominator of the terms on the other side.
- All variables are collected on the left hand side of the equation and the constants on the right hand side and then the equation is solved.



## Frequently Made Mistakes

Students make mistakes when transposing, and jumble the laws when dealing with signs.



## Sample Lesson Plan

### Topic

Linear equations

### Specific Learning Objectives

Making expressions and hence constructing equations

### Suggested Duration

1 period

### Key Vocabulary

Left hand side (LHS), Right hand side (RHS), Term, Expression, Constant, Coefficient

### Method and Strategy

### Activity

A weighing balance is brought to the class and is demonstrated that for the pans to be in equilibrium, equal weights should be placed on both sides. Thus, if oranges are put on the LHS, weights of equal mass should be placed on the RHS.

### Example

Sara's father weighs twice as much as her, and Sara's weight is 45 kg. If her father's weight is denoted by  $x$ , then:

$$2x = 45$$

Hence Sara's father weighs 90 kg.

## Written Assignments

Q # 9 of Exercise 9 should be done in class. Similar sums can be prepared by the teacher and handed to the students as a worksheet for homework.

## Evaluation

Once the students are well-versed in transposing and solving equations, a surprise class test can be taken of Q #s 3 to 10 of Exercise 9. The test can be marked and corrections can be done.

### After completing this chapter, students should be able to:

- write an algebraic equation for a statement,
- solve an algebraic equation by maintaining equilibrium on both sides, and
- solve an algebraic equation by the transposition method.



# Basic Concepts of Geometry



## Specific Learning Objectives

- Learning specific terminology used in geometry
- Two dimensional planes and their types



## Suggested Time Frame

4 periods



## Prior Knowledge and Revision

Students have been exposed to geometry since kindergarten level. In fact, they love shapes. The students need to be curious about their environment and understand that mathematics is all around us.

The teacher can hold a brainstorming session and ask them various questions before starting this chapter.

- How many vertices does a sphere or football have?
- How many surfaces or faces are there on a cuboid pencil box?
- Is the corner of the room where the two walls and the floor meet a point?
- Have you ever noticed the shapes formed on the surface of the water when you throw a pebble in a pond?



## Real-life Application and Activities

In order to explain the concepts of a line, line segment, and rays, explain the concept of infinity. This can be linked to the fact that the number line extends at both ends to infinity and has both positive and negative numbers.

Hold one end of a length of yarn or rope and give the other end to a student who can take it all the way out of the class and out of sight. Explain that one end is going on and on to infinity.

Hold a rope with one end in each hand. Explain that this length is bounded by two end points. Ask them to use a measuring tape to measure, the dimensions of the floor of their class. A scale for the room can be provided such that every 60 cm can be represented on paper by 2 cm.

Students can be given chart paper to produce congruent drawings of books of different sizes. The room dimensions, the floor, and the walls can be drawn by specifying a scale factor. Not only will they understand line segments and end points better through this activity, but they will also understand surfaces and how they are connected to each other.

As they do the drawings, the teacher can stress that they first make a point then a line segment, and point out that when two to four line segments intersect each other, they form planes and two dimensional surfaces.



## Summary of Key Facts

Terminology and definitions in geometry are very important and need to be learnt.

- A line is a series of points that goes on forever in both directions.
- A line segment is a series of points that is bounded by two end points.
- A ray has one end point and extends infinitely only from the other end.
- A surface is flat and two dimensional and goes on to infinity.
- Collinear points lie on the same straight line.
- Non-collinear points do not lie on the same straight line.
- When two or more lines pass through the same point, they are called concurrent lines.
- Lines that do not pass through the same point are non-concurrent lines.
- Planes can be tilted, horizontal, vertical, or intersecting.
- A two dimensional figure has two dimensions: length and breadth.
- A three dimensional figure has three dimensions: length, breadth and height.



## Frequently Made Mistakes

Students generally find this chapter easy and tend not to make mistakes. However, the teacher should emphasise correct use of new terms and accurate drawings.





## Sample Lesson Plan

### Topic

Geometry

### Specific Learning Objectives

Differences between a line, a line segments, and a ray

### Suggested Duration

1 period

### Key Vocabulary

Line, Ray, Line Segment, Infinity, and End Point

### Method and Strategy

#### Activity

Once the students have learnt the three definitions, divide them into groups of three. Provide them with chart paper, rope or yarn, marker, tape, and scissors. Ask them to choose one of them and on one sheet of chart paper three students cut and paste the line, line segment, or ray. Point out to them that the line segment's end points can be highlighted at the ends of the rope with a marker, and arrows cut out for the line and ray.

### Written Assignments

Q # 2, 3, and 4 of Exercise 10 can be done in class after the activity. Sums can be completed for homework.

### Evaluation

A small test of the definitions can be given. This test can take the form of multiple choice questions or fill in the blanks.

### After completing this chapter, students should be able to:

- define a point, line segment, line, ray, straight line, and parallel lines, and
- identify different types of planes.



# Construction of Line Segments



## Specific Learning Objectives

- Functions of geometric instruments
- Construction of a line segment
- Construction of a line bisector
- Construction of a perpendicular line to a given line segment



## Suggested Time Frame

3 to 4 periods



## Prior Knowledge and Revision

Students have learnt the geometric terminology and this chapter is a direct continuation, hence no revision is required. They have constructed angles in previous grades and are familiar with the use of the protractor and ruler.



## Real-life Application and Activities

The teacher can ask them to role play civil engineers or architects. The teacher can explain that this work involves the practical use of maths.



## Summary of Key Facts

- A ruler is used to measure and construct line segments.
- A protractor is a D-shaped instrument consisting of angle values from  $0^\circ$  to  $180^\circ$ .
- It is used to measure and construct angles.
- A set square is used to construct parallel and perpendicular lines.
- A pair of compasses has a pencil at one end and a sharp point at the other. It is used to measure arcs and construct circles and semi-circles.

- A divider has a sharp point at each end and is used for measurement.
- A line bisector cuts a line segment into two equal or congruent halves.
- A perpendicular line is at right angle to the base line segment.
- A pair of compasses, ruler, and divider are used to construct line segments and line bisectors.



## Frequently Made Mistakes

Students tend to use unsharpened pencils when drawing lines and constructing shapes. The teacher should teach students how to hold a compasses as they tend to hold it incorrectly. The compasses are held from the top tip; care should be taken that the points of the pencil and the compasses are aligned.



## Sample Lesson Plan

### Topic

Perpendicular bisector

### Specific Learning Objectives

Constructing a perpendicular line bisector

### Suggested Duration

1 period

### Key Vocabulary

Perpendicular, Point of intersection, Bisector

### Method and Strategy

#### Activity

Ask the students to do the construction on chart paper. This can be done as a group activity.

Ask students to construct a line segment  $\overline{AB}$  of length 12 cm.

Then, using a protractor, show them how to construct a perpendicular bisector on the board.

A length of more than half the length of the line segment is taken and arcs are drawn above and below the line segment. The students can be asked to imagine that they are drawing a date tree above and below the line.

The points where the arcs at the top and bottom intersect each other are joined by a line using a ruler.

The halves of the line segment are measured and groups that get two exactly congruent halves are awarded points.

This can be repeated at least five times and the group with the most points wins.

## Written Assignments

Exercise 11b can to be done for homework in their notebooks.

## Evaluation

A short assessment on construction can be given. Marks should be given for neat, accurate, and correctly labelled diagrams.

### After completing this chapter, students should be able to:

- identify different geometric instruments and their function: ruler, compasses, divider, protractor, and set-square,
- construct a line segment using a ruler and a pair of compasses,
- bisect line segments, and
- draw a perpendicular to a line.



# Angles



## Specific Learning Objectives

- Types of angles
- Adding angles at a point
- Using a protractor to measure and construct angles
- Constructing an angle bisector



## Suggested Time Frame

4 to 5 periods



## Prior Knowledge and Revision

Students know that angles and their different types. They also have knowledge of measuring angles, if not of constructing them.



## Real-life Application and Activities

### Starter Activity

The teacher can give them a timed activity in which they are given three minutes to identify and note down all the angles as they can spot in the classroom.

The teacher can first revise the following key angle facts, and then time them and see how many observations are made.

- Angles are formed by two rays.
- The two rays meet at one point which is called the vertex.
- An angle is denoted by the sign  $\angle$ .
- When labelling an angle by three letters in upper case, the middle letter should denote the vertex.
- A protractor is used to measure an angle.

### Example

When a door opens, an angle is formed.

The walls in a room meet at right angles.

An angle is formed between the blades of a fan.

The table legs are right angles to the floor.



### Summary of Key Facts

- An acute angle is less than  $90^\circ$ .
- A right angle is exactly  $90^\circ$ .
- An obtuse angle is more than  $90^\circ$  and less than  $180^\circ$ .
- A straight angle is equal to  $180^\circ$ .
- A reflex angle is more than  $180^\circ$  and less than  $360^\circ$ .
- Adjacent angles lie next to each other.
- Adjacent angles on a straight line are called supplementary angles.
- Adjacent angles that add up to  $90^\circ$  are complementary angles.
- Angles at a point add up to  $360^\circ$ . There can be more than two angles at a point.
- Vertically opposite angles are equal to each other and are formed when two lines intersect at a point.



### Frequently Made Mistakes

Students often misread the protractor while constructing or measuring angles since the values begin from both ends of the protractor. The teacher should stress that whenever the protractor is placed on the base ray, the reading should be done from zero that touches the base ray.

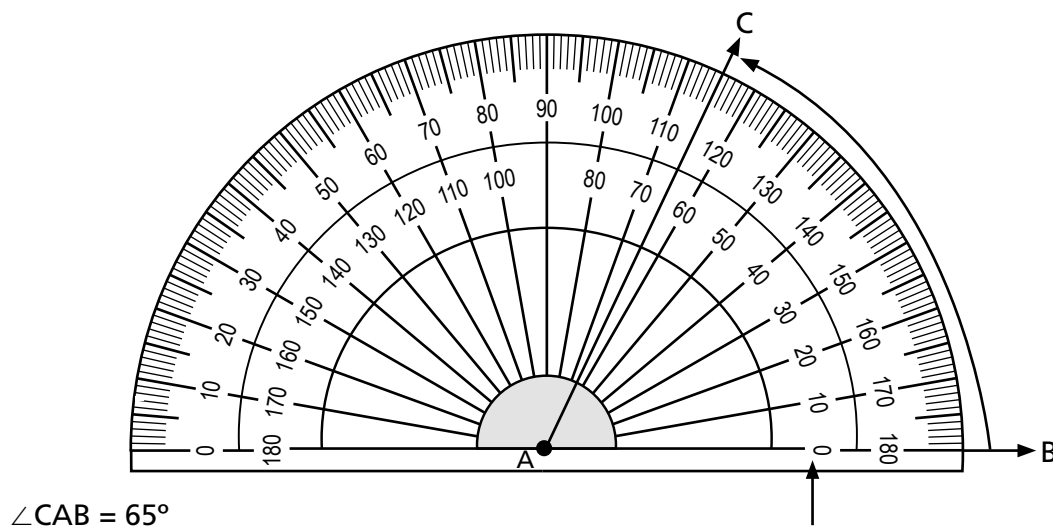



## Sample Lesson Plan

### Topic

Angles

### Specific Learning Objectives

Differentiating between complementary and supplementary angles at a point, and vertically opposite angles.

### Suggested Duration

1 period

### Key Vocabulary

Adjacent, Complementary, Supplementary.

### Method and Strategy

#### Activity

A quiz can be conducted. The teacher can make flash cards of different types of angles and as he/she shows a card, the students can write down the name of the type of angle. This is a good activity to speed up recognition of different types of angles.

The teacher can use his/her hands and show complementary angles by putting her two arms perpendicular to each other. For supplementary angles the arms are joined in a straight line. The teacher can cross his/her arms to make vertically opposite angles.

### Written Assignments

Q # 13 and 14 of Exercise 12 can be done in class. For homework, students can be given an assignment to write five sets of complementary and supplementary angles.

### Evaluation

There are many facts to be learnt in this chapter where recognition and recall will be tested. Also a student's skill in using protractor, ruler and compasses will be tested.

A comprehensive worksheet can be made to assess the students' skills and learning.

### After completing this chapter, students should be able to:

- describe an angle with reference to its arms and vertex,
- identify different types of angles: acute angle, obtuse angle, right angle, and reflex angle,
- identify angle pairs: complementary angles, supplementary angles, vertically opposite angles,
- measure and construct angles using a protractor, and
- bisect an angle using a pair of compasses.



# Triangles



## Specific Learning Objectives

- Classifying triangles according to their angles and sides
- Interior angles of a triangle add up to  $180^\circ$
- Relationship between interior and exterior angles of a triangle
- Relationship between equal sides and equal angles of a triangle



## Suggested Time Frame

4 to 5 periods



## Prior Knowledge and Revision

Students are familiar with triangles. They know that a triangle is a closed figure bounded by three sides and has three angles. Since this is a continuation of line segments, and angles and triangles are formed using these, it's an easy concept to explain.

The teacher can give a quick oral quiz on definitions of different types of angles and line segments. Students can be asked to come to the board to draw the various angles without using a protractor. The teacher can then combine the line segments drawn on the board to form a triangle.

In a 5-minute brainstorming session, students can identify triangles around them.

### *Examples*

- Fin of a shark
- Mountains and hills
- Pyramids with triangular faces
- Sail of a boat





## Real-life Application and Activities

The table on page 176 and 177 should be explained. Triangles are classified according to their sides and angles. Different types of triangles are identified according to their specific properties.

Chart paper cut outs of the six types of triangles can be made. The students can be divided into 6 groups and assigned one triangle each. They should be provided with scissors, marker, a 12" ruler, protractor, pencil, and eraser.

Ten minutes should be given to make the cut-out once the triangle type has been assigned. The cut outs can then be displayed on soft boards and points can be awarded to the groups.



## Summary of Key Facts

- A scalene triangle has all sides unequal, hence all angles are also unequal.
- An isosceles triangle has two equal sides and two equal angles.
- An equilateral triangle has all sides and all angles equal.
- An acute-angled triangle has all acute angles.
- A right-angled triangle has one angle equal to  $90^\circ$  and two acute angles.
- An obtuse-angled triangle has one obtuse angle and two acute angles.
- An exterior angle is formed by the extension of one of the sides of a triangle externally.
- Interior angles are inside the triangle at the vertices.
- The exterior angle is equal to the sum of the two opposite interior angles.
- All three interior angles of a triangle add up to  $180^\circ$ .
- The length of the third side is always less than the sum of the length of other two sides.

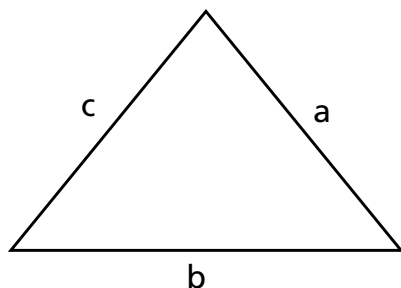

$$a + b > c$$

$$a + c > b$$

$$b + c > a$$



## Frequently Made Mistakes

The students generally enjoy this topic. If the students learn the properties of triangles well, mistakes are very rare. Students sometimes do not observe that the exterior angle is not just any angle formed outside the triangle but one that is formed by the collinear extension of the side of a triangle.



# Sample Lesson Plan

## Topic

Triangles

## Specific Learning Objectives

- Properties of a triangle
- Sum of interior angles of a triangle
- Relationship between exterior and interior angles of a triangle

## Suggested Duration

1 period

## Key Vocabulary

Exterior angles, and Interior angles

## Method and Strategy

### Activity

The property that the sum of the three interior angles of a triangle is  $180^\circ$  can be practically demonstrated by giving students cut outs of various sizes of triangles. Each student can be handed a cut out of one of the six types of triangles studied. They should be asked to label the triangle and then identify its type first. Then, they should cut out the three angles and glue them in their notebooks adjacent to each other. The students will notice that all three angles can be pasted in a straight line, proving that the three interior angles of a triangle add up to  $180^\circ$ .

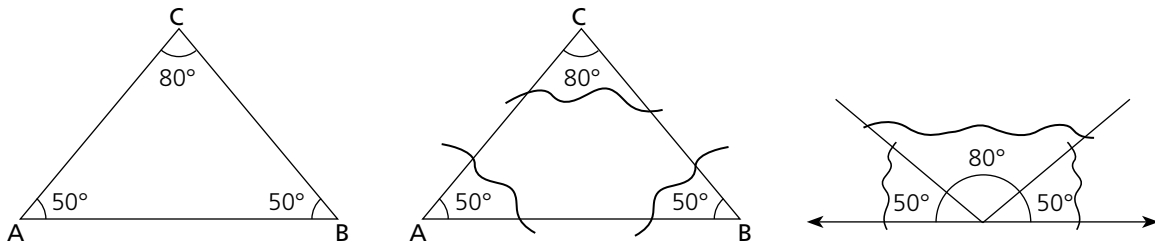

This activity can be repeated by cutting out an exterior angle from another cut-out of a triangle with an extended side and cutting and pasting the two opposite interior angles on top of the exterior angle. When the students prove these properties practically themselves, they understand and retain the concept better.

Ask the students to write the property proved under the angles glued in their notebooks.

## Written Assignment

Q # 5 to 13 of Exercise 13b can be given for homework to ascertain whether they have learnt and understood the properties through the activity.

## Evaluation

Short pop quizzes in the beginning of each class can be taken. The teacher can write five questions on the board and ask them to complete the quiz in five minutes. In this way the retention of the information about the properties and different types of triangles can be checked. An assessment can be given in which the students are asked to draw six types of triangles using a protractor, compasses and a ruler. Multiple choice questions can be given on the properties of the angles of the triangles.

### After completing this chapter, students should be able to:

- identify and name different types of triangles according to their sides and angles: scalene, isosceles, and equilateral triangles, and right-angled, acute-angled, and obtuse-angled triangles, and<sup>o</sup>
- find the interior and exterior angles by applying the properties of angles of a triangle.



# Mensuration: Area



## Specific Learning Objectives

- Area and its units
- Using squared paper to find the area of an irregular or regular shape
- Formulae for finding the area of a rectangle and a square



## Suggested Time Frame

5 to 6 periods



## Prior Knowledge and Revision

Students know that the space enclosed by two dimensions is called the area of a figure.

This chapter deals with the transition from one dimensional to two dimensional figures. Brain storming session to identify surfaces around the classroom or in the playground. The walls, surfaces of tables, shelves, floor, and board etc. can be pointed out to show that they have two-dimensional surfaces.



## Real-life Application and Activities

Explain that the area of irregular objects is found by tracing them onto squared paper and then counting the squares. An interesting activity can be done to demonstrate this.

Ask students to bring to class a picture of their favourite cartoon character or any other picture of their choice.

**Example:**

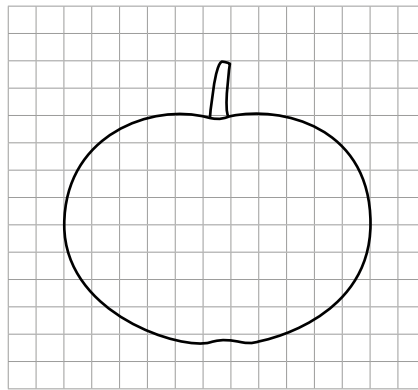

The teacher should make sure the picture doesn't exceed the size of a sheet of A4 paper. Then ask the students to trace their picture onto the squared paper and count the squares to find its area in square units.

Similarly, the formulas of a rectangle and a square can be explained.

Area of rectangle = length  $\times$  breadth

Area of square = side  $\times$  side =  $s^2$

These formulas can be explained by drawing a rectangle and square on squared paper and finding their areas by counting the squares. Once the students have found the area, the teacher can count the number of squares in the length and breadth and multiply them to show that the answer is the same and it is a faster route to finding the area. The teacher should explain that formulas are devised to make our lives easier.

Students can then be given measuring tapes and the areas of their book pages, surfaces of the table, and board can be found. Students can work in groups for this task.

The teacher should prepare a worksheet in the form of a table where a column for each surface is given in which length and breadth are found and noted and then the area formula is applied and the answer is given in square cm. Students are given ten minutes to do this activity and then worksheets are handed in and the groups are marked on their accuracy and neatness.



## Summary of Key Facts

- The area of an irregular shape is found by tracing the shape onto squared paper and counting the squares. Squares that are exactly half are clubbed with other halves and added: squares smaller than half are ignored, and those greater than half are counted as one whole.
- The area of a rectangle is the product of its length and breadth.
- The area of a square is the square of its side.
- Finding the cost of tiling, painting, or cementing a particular area is done by the unitary method where the cost of one square metre or centimetre is provided.
- The area of a border is found by subtracting the internal area from the external area.



## Frequently Made Mistakes

Students get confused when manipulating the formula to find a dimension when given an area. Explain that this should be treated as an algebraic expression with the unknown dimension represented by the 'x' variable and the other value transposed to find the answer. Also, it should be pointed out that the units for all values should be uniform.

### *Example*

$$\text{Area} = 36 \text{ cm}^2$$

Breadth = 0.04 m = 4 cm (Students should be careful with units and their conversions.)

$$A = \text{length} \times \text{breadth}$$

$$36 = \text{length} \times 4$$

$$\text{Length} = \frac{36}{4} = 9 \text{ cm}$$



## Sample Lesson Plan

### Topic

Area

### Specific Learning Objectives

Finding the area of a border of equal thickness enclosed by two rectangles

### Suggested Duration

1 period

### Key Vocabulary

External area, Internal area, Inner length, outer length, breadth

### Method and Strategy

#### Activity

This is a difficult concept for students. There should be ample practice of finding areas using the formulas before this is introduced.

The fact that the border is of equal widths should be pointed out. Identification of the inner length and breadth and the outer length and breadth should be done. In order to find the inner dimensions, the widths are subtracted twice from the outer dimensions. Similarly, the width is added twice to the inner dimensions to get the outer dimensions.

Once the dimensions are tabulated, inner and outer areas are found and subtracted to get the area of the border.

Finding the measurements of the inner rectangle ABCD

Length of AB

$$= 8 \text{ cm} - 1 \text{ cm} - 1 \text{ cm} = 6 \text{ cm}$$

Length of BC

$$= 6 \text{ cm} - 1 \text{ cm} - 1 \text{ cm} = 4 \text{ cm}$$

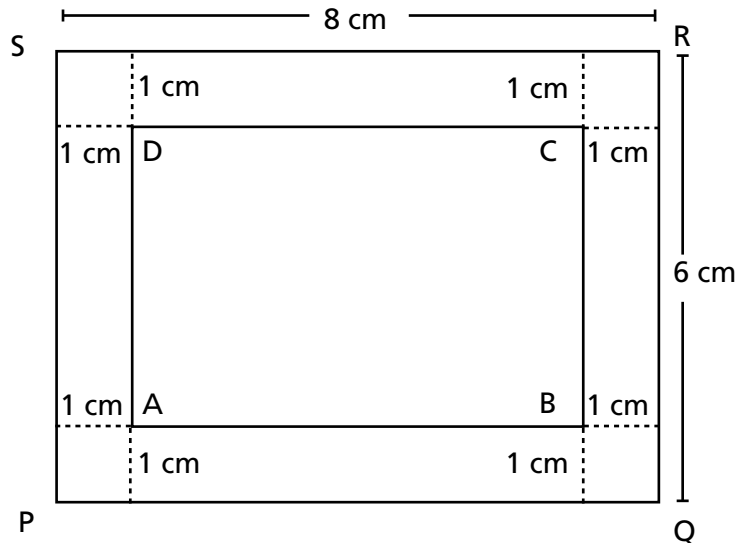

A fun activity can be done.

Students are asked to cut out two rectangles from sheet of different colored chart paper:

rectangle 1 with a length of 10 cm and a breadth of 5 cm, and

rectangle 2 with a length of 14 cm and a breadth of 9 cm.

The cut outs should be of two different colours. Ask the students to stick the smaller rectangle onto the larger one. Students calculate the areas of the two rectangles and then subtract these two areas to get the area of the border.

Likewise, a rug could be brought to the lesson and its dimensions and area can be measured using a measuring tape. The teacher marks an area on the floor where the rug is placed and subsequently the marked area of the floor is also measured. The students can then calculate the area not covered by the rug.

## Written Assignments

Q # 6 of Exercise 14b can be done in class. The students should write the data carefully and then do the working. Five sums can be given for homework.

## Evaluation

This is an important topic. A lot of short tests should be given to assess students' understanding and learning. Once the teacher is confident, the next topic should be explained.

A comprehensive assessment comprised of finding area of irregular shapes on squared paper, finding the missing dimension using the given area, word problems to find the cost of cementing or tiling using the unitary method, and border questions should be given.

**After completing this chapter, students should be able to:**

- define area and its units,
- measure the area of a plane surface by using squared paper,
- calculate the area of a square and a rectangle using the formulae, and
- solve real-life problems based on area.



# Mensuration: Volume



## Specific Learning Objectives

- Volume and its units
- Volume of cubes and cuboids
- Surface area of cubes and cuboids



## Suggested Time Frame

4 to 6 periods



## Prior Knowledge and Revision

Students are familiar with the concept of volume. They know that all 3D figures have volume. It is the space contained by the length, breadth, and the third dimension, height.

Hold a quick quiz in which 3D objects in the classroom are identified by their name, surfaces, edges, and vertices.

The moment a square or rectangular face acquires thickness or height it becomes a 3D figure with volume. The best example would be to lift a page of a book and show it to be a rectangle with length and breadth. Close the book and show the height or thickness of the book: the pages have become a cuboid which is a 3D figure.



## Real-life Application and Activities

The identification of dimensions of cubes and cuboids is very important as the students need to identify them and then substitute the values in the formulas. The best way to ensure that the students understand this is to make net diagrams of a cube and a cuboid. The teacher should draw the net diagram on chart paper and ask the students to cut, fold, and tape the shapes.



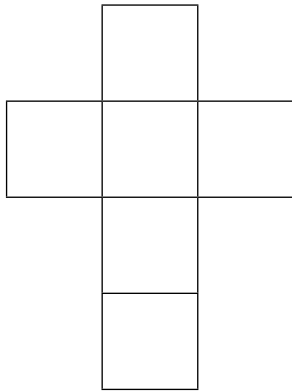

### Net diagram of a cube

Since all sides are equal, all the faces are equal in area and dimensions.

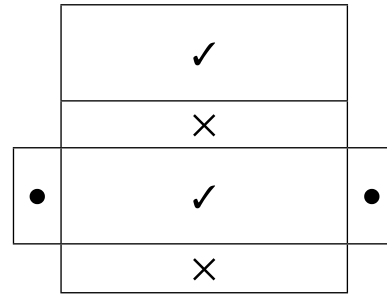

### Net diagram of a cuboid

Since dimensions are different, opposite faces, are the same in area and dimensions.



## Summary of Key Facts

Conversion of units is very important.

1 cubic metre = 1000 litres

1 litre = 1000 cubic centimetre

Volume of a cuboid = Length × Breadth × Height

Total surface area of a cuboid  $2(l \times b) + 2(b \times h) + 2(l \times h)$

Volume of a cube = Length × Breadth × Height

Since all dimensions of a cube are uniform, breadth and height can be replaced with length.

Therefore, volume of a cube =  $l \times l \times l = l^3$

Total surface area of a cube =  $2(l \times l) + 2(l \times l) + 2(l \times l)$   
 $= 2l^2 + 2l^2 + 2l^2$   
 $= 6l^2$



## Frequently Made Mistakes

The students find this topic very difficult. They tend to use the wrong formula or wrong conversion units. Care should be taken that they not only understand and then learn the formulas, but are also confident converting the units.



## Sample Lesson Plan

### Topic

Surface Area of a Cube

### Specific Learning Objectives

Calculating surface area of cubes

### Suggested Duration

1 Period

### Key Vocabulary

Cubes, Surface area, Faces, Edges

### Method and Strategy

#### Activity

Cubes are objects for which all three dimensions are equal. Ask the students to bring any everyday cube shaped object to school, it could be a box of chocolates or a toy box. Ask the students to feel and count the faces of the object; they will all feel the faces and point out that there are 6 equal faces. Since all dimensions are the same,  $2(l \times b) + 2(l \times h) + 2(b \times h)$  simply translates to  $2l^2 + 2l^2 + 2l^2 = 6l^2$

The formula for finding the surface areas of a cube is  $6l^2$ .

### Written Assignments

Students can be given three sums to do for classwork and six sums as homework, where the teacher can ask them to find the surface area of cubes measuring 2, 3, 4, 5, 6, 7, 8, 9, and 10 cm each.

### Evaluation

This is an extremely critical chapter where the conceptual, practical, and practice aspects are to be kept in mind. Quizzes should be given after every concept taught. Only if the majority of the students score well, should the teacher proceed to a new topic. Word problems of surface area, costing, and finding the missing dimension with the help of volume should also be given.

A comprehensive assessment including applications of formulas for volume and total surface area, and more importantly, word problems should be given.

### After completing this chapter, students should be able to:

- define volume and its units,
- find the volume of a cube and cuboid using the formulas,
- find the surface area of a cube and cuboid using the formulas, and
- solve real-life problems based on volume and surface area.



# Information Handling



## Specific Learning Objectives

- Grouped and ungrouped data
- Pictorial representation of numeric data
- Functions of graphs and their scale
- Constructing horizontal and vertical bar charts



## Suggested Time Frame

3 to 4 periods



## Prior Knowledge and Revision

Students have interpreted line graphs and bar graphs in earlier classes.

The teacher can draw line graphs on the board and ask questions. It could be a line graph depicting the temperature of their city on the last 7 days.

The students and the teacher can draw a bar graph of their favourite game.

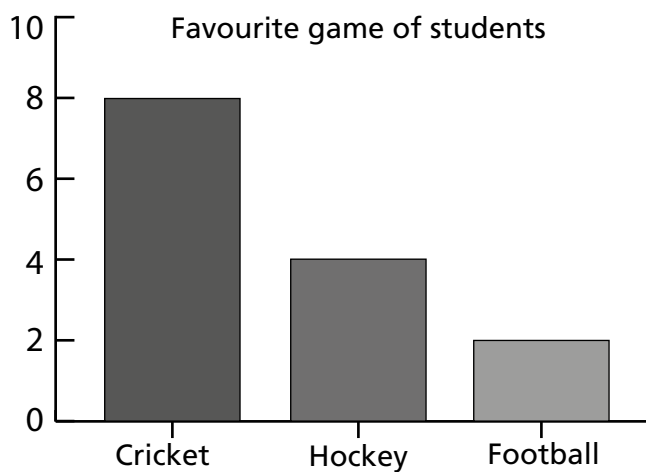



## Real-life Application and Activities

The teacher can measure the heights of a group of five students and then represent the findings on a bar graph on the board. This can also be done on chart paper and displayed on the soft board for a week.

The students can then be divided into groups and each group can be given a different set of data and asked to draw a vertical or horizontal bar graph on chart paper. The groups can then be marked on accuracy, presentation, and labelling of the graph.

The teacher should then set a homework assignment of finding out the height of each family member and representing the information on a horizontal bar graph in their notebooks.



## Summary of Key Facts

- Statistics deals with the collection, organization, and interpretation of data.
- Ungrouped data does not have any frequency recorded.
- Graphs can be pictographs or vertical or horizontal graphs.
- Pictographs have a suitable scale in the form of a diagram. If it is representing books, a picture of a whole book could represent 5000 units, a picture of half a book 2500 units, and a picture of a quarter of a book 1250 units.
- A bar graph represents data in rectangles, either placed vertically or horizontally. These rectangles are called bars.



## Frequently Made Mistakes

Special emphasis should be placed on scale drawing, labelling, and accuracy. Students tend to forget this aspect and can be careless in their presentation. It should be stressed that the bars are of equal widths and the intervals between them should also be uniform.



## Sample Lesson Plan

### Topic

Bar graphs

### Specific Learning Objectives

Concept of scale while drawing bar graphs

### Suggested Duration

1 period

### Key Vocabulary

Vertical and horizontal axis, Bars, Gaps, Intervals, Scale

## Method and Strategy

### Activity

Bar graphs can be either horizontal and vertical.

A good way of explaining scale while drawing a bar graph would be by linking it with rate.

If 2 tables cost Rs 5000, then one table would cost Rs 2500. A centimetre in a bar can represent a grading of Rs 2500.

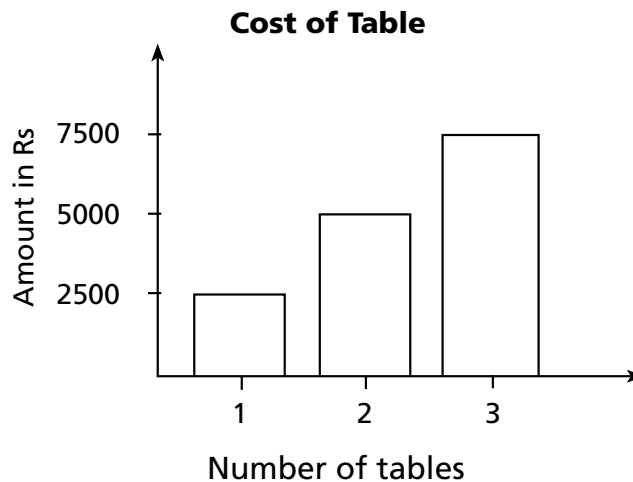

### Written Assignments

Q # 4 of Exercise 16 can be done in class. Questions 5 and 6 can be discussed in class and then given for homework.

### Evaluation

This chapter is more presentation-based. Evaluation could be done as a group activity in which the students are assessed on a pictograph and bar graph presented by the group on chart paper.

A 15-minutes marked quiz could be given on Q # 7 and 8 of Exercise 16.

### After completing this chapter, students should be able to:

- suggest appropriate ways of organising numerical data,
- construct pictographs using an appropriate scale,
- construct horizontal and vertical bar graphs for a given set of data, and
- read horizontal and vertical bar charts.



# Assessment

A teacher's journey involves three stages Exposition, Practice, and Consolidation.

Exposition is the setting forth of content, and the quality and extent of the information relayed.

Practice involves problem solving, reasoning and proof, communication, representations, and correction.

Assessment is the final stage of consolidation of the process of learning. Assessment of teaching means taking a measure of its effectiveness.

**Formative** assessment is measurement for the purpose of improving it.

**Summative** assessment is what we normally call evaluation.

An ideal and fair evaluation involves a plan that is comprehensive. It covers a broad spectrum of all aspects of mathematics. The assessment papers should test all aspects of topics taught. These can be demarcated into categories: basic, intermediate, and advanced content. The advanced content should be minimal as it tests the most able students only.

Multiple choice questions, also known as fixed choice or selected response items, required students to identify the correct answer from a given set of possible options.

Structured questions assess various aspects of students' understanding: knowledge of content and vocabulary, reasoning skills, and mathematical proofs.

All in all the teacher's assessment of students' ability must be based on classroom activity, informal assessment, and final evaluation at the end of a topic and/or the year.

# Specimen Paper

## Mathematics

### Grade 6

#### Section A

Time: 1 hour

Total Marks: 40

Select the correct answer from the given options.

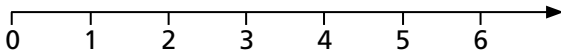
1.	Which of the following forms a set?  A. Set of young people in a city B. Set of brave boys in the school. C. Set of numbers between 70 and 90 D. Set of interesting books.	5.	The following number line represents    A. natural numbers. B. real numbers. C. whole numbers. D. rational numbers.
2.	A pictorial representation of a set is  A. tabular form. B. Venn diagram. C. descriptive notation. D. set builder form.	6.	$0 + 9 = 9$ . This is called the  A. associative property of addition. B. closure property of addition. C. commutative property of addition. D. additive property.
3.	If $A = \{\text{Number of musicians in a group}\}$ then A is a  A. finite set. B. infinite set. C. empty set. D. unit set.	7.	In 69852, the face value of 8 is  A. 850 B. 800 C. 8 D. 852
4.	If $A = \{x, y, z, i, j, k\}$ and $B = \{x, y, j, k\}$ then,  A. $B \supset A$ B. $B = A$ C. $A \subset B$ D. $B \subset A$	8.	The prime factors of 44 are  A. $2 \times 2 \times 2 \times 2 \times 2$ B. $2 \times 2 \times 11$ C. $4 \times 11$ D. $2^2 \times 2$

9.	81984 is divisible by A. 2, 3, 4 B. 5, 6, 7 C. 2 only D. 4 only	14.	Integers are infinite series of A. positive numbers only. B. negative numbers only. C. positive and negative numbers. D. odd numbers.
10.	118 is a multiple of A. 59 B. 18 C. 10 D. 54	15.	Evaluate $13 + 9 + (-9) - 8$ A. 5 B. 23 C. 21 D. 15
11.	6, 8, 10 and 12 are A. prime number. B. perfect numbers. C. composite numbers. D. square numbers.	16.	$3 \times (4 + 7) = 3 \times 4 + 3 \times 7$ is A. commutative property of multiplication. B. distributive property of multiplication over addition. C. associative property of multiplication. D. distributive property of addition.
12.	LCM of 8, 12 and 32 is A. 32 B. 96 C. 48 D. 13	17.	$18 : 27 : 63$ in its simplest form is A. 6 : 9 : 21 B. 2 : 3 : 7 C. 6 : 9 : 3 D. 9 : 9 : 9
13.	The HCF of 28 and 72 is A. 12 B. 72 C. 4 D. 100	18.	Which of the following ratio is the greatest? A. 8 : 9 B. 5 : 13 C. 7 : 8 D. 5 : 6
19.	0.65 expressed as a percentage is A. 65% B. 6.5% C. 650% D. 0.65%	20.	If 30% of a number is 30, the number is A. 300 B. 100 C. 900 D. 90

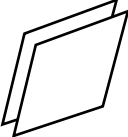

21.	$\frac{13}{25}$ expressed as a percentage. <b>A.</b> 13% <b>B.</b> 52% <b>C.</b> 22% <b>D.</b> 65%	26.	$x - 5 = 4$ ; $5 - y = 4$ The above statements are true for <b>A.</b> $x = 1, y = 1$ <b>B.</b> $x = 9, y = -1$ <b>C.</b> $x = 9, y = 1$ <b>D.</b> $x = 1, y = 0$
22.	18% expressed as a fraction in lowest term <b>A.</b> $\frac{9}{12}$ <b>B.</b> $\frac{18}{50}$ <b>C.</b> $\frac{9}{50}$ <b>D.</b> $\frac{100}{18}$	27.	$\frac{xy}{a} = 1$ is true for <b>A.</b> $x = 2, y = 6, a = \frac{1}{6}$ <b>B.</b> $x = \frac{1}{2}, y = 2, a = 1$ <b>C.</b> $x = 4, y = 2, a = 2$ <b>D.</b> $x = \frac{1}{3}, y = 9, a = 1$
23.	Profit percentage = <b>A.</b> selling price – cost price <b>B.</b> $\frac{\text{Profit}}{100} \times \text{cost price}$ <b>C.</b> $\frac{\text{Profit}}{\text{cost price}} \times 100\%$ <b>D.</b> $\frac{\text{Profit}}{\text{selling price}} \times 100\%$	28.	A line segment is a series of points <b>A.</b> extending infinitely at both ends. <b>B.</b> extending towards left. <b>C.</b> bounded at both ends. <b>D.</b> extending towards right.
24.	Simple interest is the money <b>A.</b> earned on the amount. <b>B.</b> borrowed from the bank. <b>C.</b> earned on the principal. <b>D.</b> deposited in the bank.	29.	A ray is a part of a line with <b>A.</b> two end points. <b>B.</b> ends extending infinitely. <b>C.</b> no end points. <b>D.</b> one end point.
25.	Simplify: $4a - 6b + 2c + 2a - b - c$ <b>A.</b> $6a - 5b + C$ <b>B.</b> $6a + 5b + c$ <b>C.</b> $6a - 4b + 3c$ <b>D.</b> $6a - 7b + c$	30.	These two planes are <b>A.</b> intersecting each other. <b>B.</b> parallel to each other. <b>C.</b> perpendicular to each other. <b>D.</b> make an angle of $60^\circ$ with each other. 

31.	<p>Half of a right angle is</p> <p>A. <math>90^\circ</math>  B. <math>45^\circ</math>  C. <math>9^\circ</math>  D. <math>180^\circ</math></p>	35.	<p>Perimeter of a rectangle with length '<math>l</math>' and breadth '<math>b</math>' is</p> <p>A. <math>l + b</math>  B. <math>l \times b</math>  C. <math>l \times l + b \times b</math>  D. <math>2(l + b)</math></p>
32.	<p>Which of the following is a reflex angle?</p> <p>A. <math>180^\circ</math>  B. <math>280^\circ</math>  C. <math>100^\circ</math>  D. <math>60^\circ</math></p>	36.	<p>1000 cubic cm equals to</p> <p>A. 1000 litres  B. 100 litres  C. 1 litre  D. 10 litres</p>
33.	<p>An isosceles triangle has</p> <p>A. two equal sides.  B. three equal sides.  C. all sides unequal.  D. three equal angles.</p>	37.	<p>A cuboid has</p> <p>A. two dimensions.  B. one dimension.  C. three dimensions.  D. six dimensions.</p>
34.	<p>Area of border around a rectangle is same as</p> <p>A. area of rectangle.  B. area of rectangle + area of border.  C. area of border – area of rectangle.  D. area of outer rectangle – area of inner rectangle.</p>	38.	<p>The weight of ten children are given below:  35 kg, 30 kg, 37 kg, 25 kg, 18 kg,  20 kg, 19.5 kg, 32.7 kg, 17 kg, 12.9 kg</p> <p>The above information is in the form of</p> <p>A. a grouped data.  B. an ungrouped data.  C. a chart.  D. a table.</p>

39. Below is a bar graph representing number of patients visiting a clinic in a week.

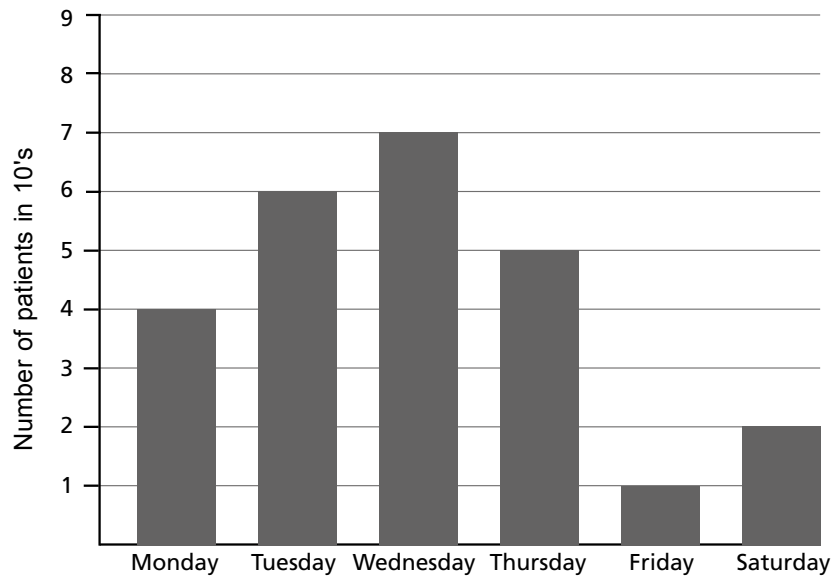

What percentage of patients visited on Monday?

- A. 16%
- B. 24%
- C. 28%
- D. 20%

40. The line graph below shows Ahmed's travelling in a week.

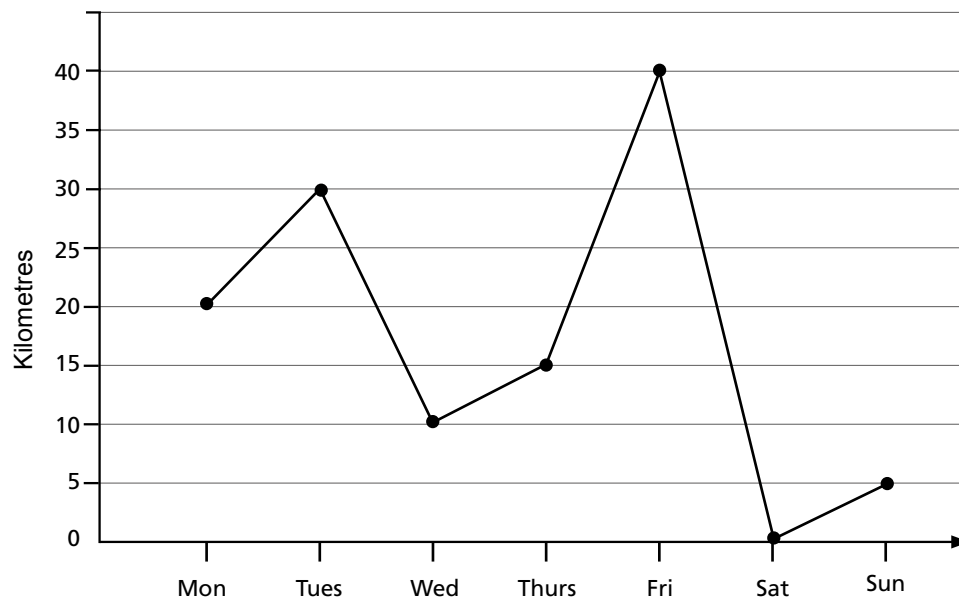

On Saturday Ahmed travelled

- A. 40 km
- B. 10 km
- C. 0 km
- D. 115 km

## Section B

Time: 2 hours

Total Marks: 60

- Q1 (i) Write the set  $A = \{-3, -2, -1, 0, 1, 2, 3, 4\}$  in set builder form. [3]  
(ii) Simplify  $5 \times 625 + 2 \times 625$ . [3]  
(iii) Find the HCF of 42, 56, 21. [3]  
(iv) Find the LCM of 36, 48 and 16. [3]

[Total marks: 12]

- Q2. (i) The product of two integers is 85. If one of them is  $-17$  find the other integer. [3]  
(ii) A drink made of milk and chocolate syrup contains 750 ml of milk and 250 ml of chocolate syrup. What is the ratio of milk to chocolate syrup? Give your answer in simplest form. [3]  
(iii) If 4 farmers plough a field in 28 days. How many farmers will plough the same field in 16 days? [3]  
(iv) If  $P = \text{Rs } 80,000$ ,  $R = 15\%$  and  $T = 3$  years, calculate the simple interest. [3]

[Total marks: 12]

- Q3. (i) Amir bought a book shelf for Rs 16,000. If he sold it for Rs 18,000, find his profit and profit%. [5]  
(ii) Find the length of a rectangular field, whose breadth is 15 cm and area is  $180 \text{ cm}^2$ . [4]  
(iii) Solve  $9x + 7 = 15x - 23$ . [3]

[Total marks: 12]

- Q4. (i) Draw an angle of  $140^\circ$  and bisect it with the help of compasses. Write the measure of the bisected angle. [4]  
(ii) Find the value of  $x^\circ$  in the figure given below. [3]

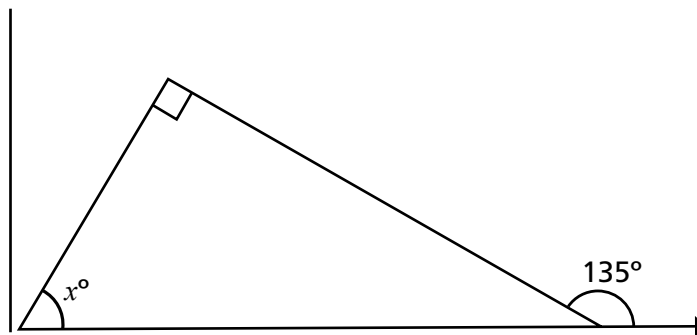

- (iii) The dimensions of a cubical plastic container is 25 cm by 10 cm by 12 cm. How much liquid can it hold? Give your answer in litres. [5]

[Total marks: 12]

- Q5. (i) Simplify :  $8 [7a - \{2 (a - \overline{b - 2 a})\}]$  [3]
- (ii) What must be added to  $p^3 + 6p^2 + 8p - 12$  to obtain  $p^3 + 6p^2 - 3p + q$ ? [3]
- (iii) Evaluate  $\frac{x^2 - y}{y^2 - x} - z$ , if  $x = 7$ ,  $y = 5$ , and  $z = 2$ . [3]
- (iv) Study the bar graph shown below and answer the question.

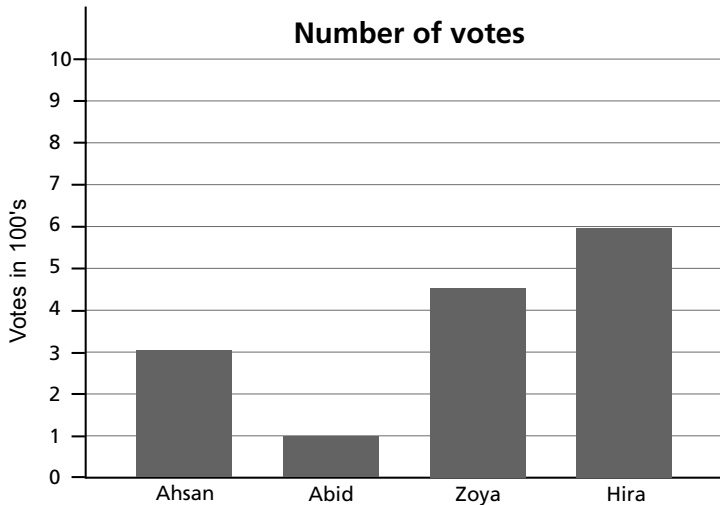

- (a) Who received the highest number of votes? [1]
- (b) How many votes did Abid receive? [1]
- (c) What are the total number of votes secured by Zoya and Ahsan? [1]

[Total marks: 12]

# Marking Scheme

Marking criteria for Section A: 1 mark for each correct answer.

## Answers

1. C	2. B	3. A	4. D	5. C	6. B	7. C	8. B
9. A	10. A	11. C	12. B	13. C	14. C	15. A	16. B
17. B	18. A	19. A	20. B	21. B	22. C	23. C	24. C
25. D	26. C	27. B	28. C	29. D	30. B	31. B	32. B
33. A	34. D	35. D	36. C	37. C	38. B	39. A	40. C

## Marking criteria for Section B

Q.1		12 Marks	Answer		
	(i) • Recognition of set-builder form [1] • Using symbol $x   x$ [1] • Correct statement [1]	3 marks	{ $x   x$ lies between $-4$ and $5$ } or { $x   -3 \leq x \leq 4$ }		
	(ii) • Using DMAS [1] • Using associative law [1] • Calculation and accuracy [1]			3 marks	4375
	(iii) • Prime factorization [1] • Selection of correct factor [1] • Accurate answer [1]				
	(iv) • Factorization [1] • Multiplication [1] • Accurate answer [1]			3 marks	LCM: 144
Q.2		12 Marks	Answer		
	(i) • Using multiplication [1] • Product of different signs [1] • Calculation and correct answer [1]	3 marks	-5		
	(ii) • Correct order of ratio [1] • Simplest form [1] • Accurate answer [1]			3 marks	3:1
	(iii) • Application of unitary or ratio method [1] • Correct placing of figures [1] • Correct answer [1]				
	(iv) • Formula of simple interest [1] • Finding simple interest [1] • Accurate answer [1]			3 marks	Rs 36,000

Q.3		12 marks	Answer
	(i) • Finding profit [1] • Applying formula for percentage [2] • Accuracy in calculation [1] • Answer statement [1]	5 mark	Profit = Rs 2000; Profit % = $12\frac{1}{2}$ %
	(ii) • Method or formula [2] • Accuracy in calculation [1] • Answer statment [1]	4 mark	12 cm
	(iii) • Shifting of like terms [1] • Correct signs [1] • Correct answer [1]	3 mark	$x = 5$
Q.4		12 marks	Answer
	(i) • Drawing an angle [1] • Bisection of angle [2] • Measuring accurate angle [1]	4 mark	$70^\circ$
	(ii) • Finding supplementary angle and correct application for sum of the angles of a triangle OR [2] Correct application of exterior angle equals to the sum of opposite interior angle • Accurate answer [1]	3 mark	$x = 45^\circ$
	(iii) • Finding volume [2] • Conversion of $\text{cm}^3$ into litre [2] • Accurate answer [1]	5 mark	3 litres
Q.5		12 marks	Answer
	(i) • Opening of brackets (correct order) [2] • Correct answer [1]	3 marks	$8a + 16b$
	(ii) • Correct placement of expressions [1] • Correct solution [2]	3 marks	$-11p + q + 12$
	(iii) • Substituting the values [2] • Accuracy in calculation [1]	3 marks	$\frac{4}{9}$
	(iv) • Correct answer [3]	3 marks	(i) Hira (ii) 100 (iii) 750

